



# Mounts

CATALOGUE

2024

gobay®

1	MONITOR MOUNTS	3
1.1	MONITOR MOUNTS	4
1.2	MONITOR MOUNTS – WORKSTATION	10
1.3	MONITOR MOUNTS – LAPTOP MOUNTS	11
1.4	MONITOR MOUNTS – GAMING & BUSINESS CURVED XL	12
2	TV MOUNTS	13
2.1	TV WALL MOUNTS – FIXED	16
2.2	TV WALL MOUNTS – TILT	22
2.3	TV WALL MOUNTS – FULLMOTION	26
2.4	TV WALL MOUNTS – ACCESSORIES	32
2.5	TV WALL MOUNTS – UNIVERSAL	33
2.6	TV CEILING MOUNT	34
2.7	TV FLOOR STANDS & FEET	35
3	SPEAKER MOUNTS	38
4	PROJECTOR MOUNTS	43
5	CARAVAN – TV WALL MOUNTS	45
6	OVERVIEW MOUNTS	49

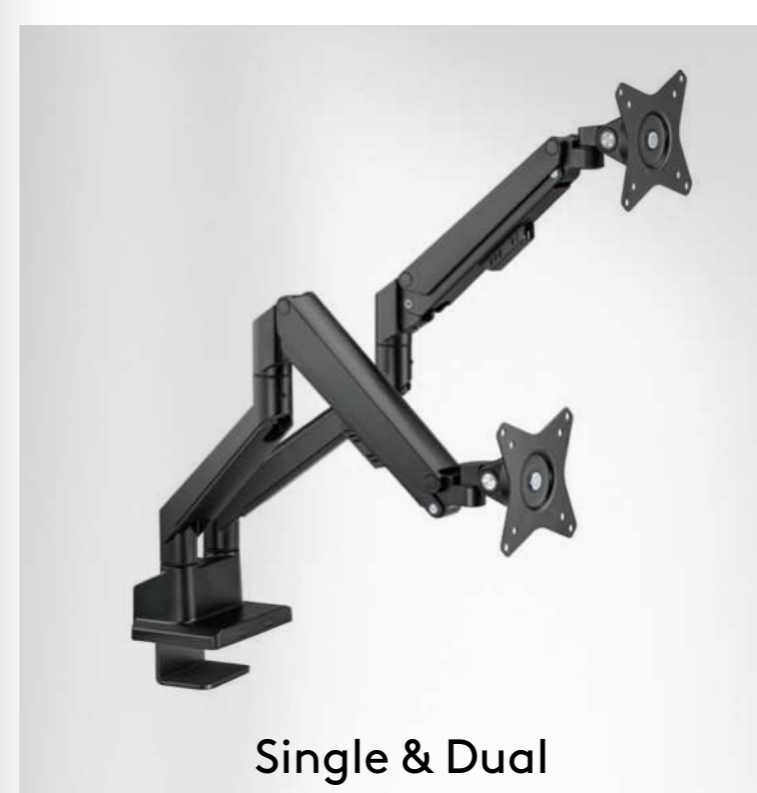

Single &amp; Dual

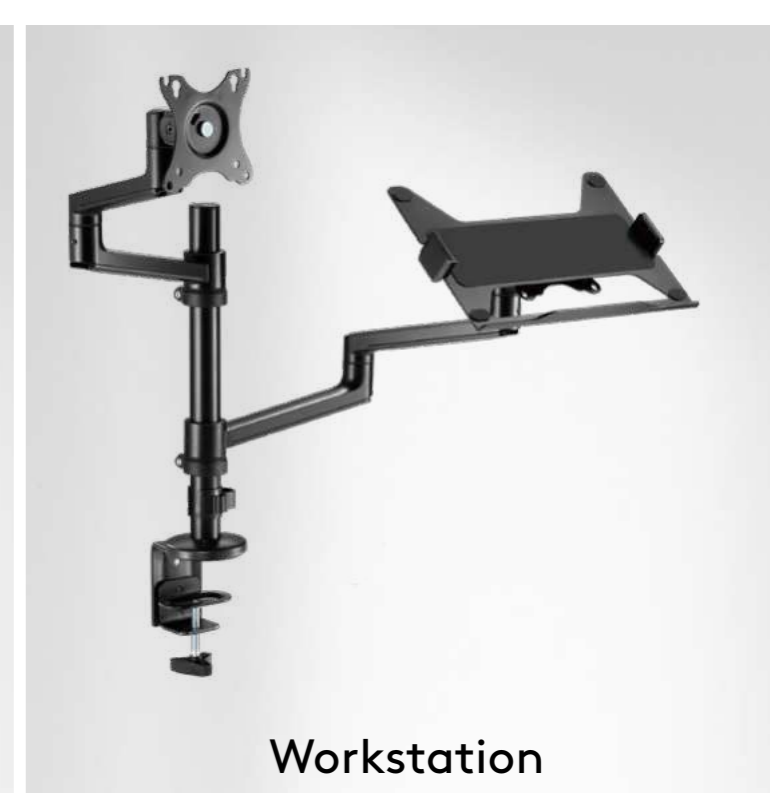

Workstation

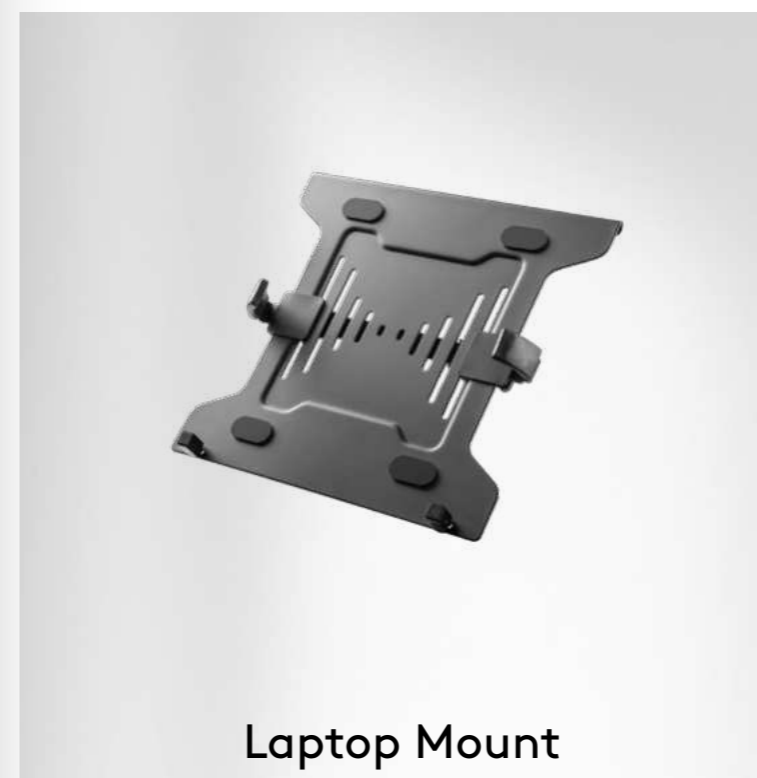

Laptop Mount



Gaming &amp; Business Curved XL

## MONITOR MOUNTS

### SIMPLY FULLY FLEXIBLE

ERGONOMIC, SMOOTH, FLEXIBLE – OUR AGILE ALL-ROUNDERS OFFER OUTSTANDING CONVENIENCE AT THE DESK AND IN THE OFFICE



### The Basic Series

The monitor mount is the perfect addition to the ergonomic workplace and adapts to all of your everyday requirements.

- With its slim base, the robust monitor stand is the space-saving solution for the desk at home or in the office
- The integrated cable management system of the monitor arm protects the cables and creates a clean look without cable clutter
- Installation is quick and easy with the included mounting material, either using a screw with drill hole or a table clamp that can be removed without leaving any residue
- Recommended tabletop thickness for both mounting variants of the monitor stand: 10-85 mm
- The monitor mount is compatible with the VESA® standards 75x75 mm and 100x100 mm



#### Goobay Basic

#### Monitor Mount Single Flex

for curved and flat monitors between 17 and 32 inches (43-81 cm) up to 8 kg

- Perfect for the stable desk mounting of a screen up to 8 kg via a clamp, height-adjustable, 90° tiltable, 180° swivelling, 360° rotation
- Incl. removable, VESA®-compatible mounting plate for an easy replacement of individual monitors without tools



58528 Retail Box

RRP 39.99 €



#### Goobay Basic

#### Dual Monitor Mount Flex

for curved and flat monitors between 17 and 32 inches (43-81 cm) up to 8 kg each

- Perfect for the stable desk mounting of two screens up to 8 kg each, height-adjustable, 90° tiltable, 180° swivelling, 360° rotation
- Incl. removable, VESA®-compatible mounting plate for an easy replacement of individual monitors without tools



58529 Retail Box

RRP 49.99 €



#### Goobay Basic

#### Double Monitor Mount Fix

for curved and flat monitors between 17 and 32 inches (43-81 cm) up to 9 kg each

- Perfect for the stable desk mounting of two screens up to 9 kg each, height-adjustable, 45° tiltable, 15° swivelling, 180° rotation
- Easy to align: The horizontal rail allows for swivelling two monitors at a fixed angle to each other with just one hand movement



59394 Retail Box

RRP 49.99 €





### Goobay Basic

#### Monitor Mount with Gas Spring

for curved and flat monitors between 17 and 32 inches (43-81 cm) up to 9 kg

- Perfect for the stable desk mounting of a screen up to 9 kg, height-adjustable, swivelling and tilting
- Thanks to the gas spring, you can easily bring the monitor into the ideal, ergonomic position at any time without any effort - whether for working, gaming or video calls



58530 Retail Box

RRP 39.99 €



### Goobay Basic

#### Double Monitor Mount with Gas Spring

for curved and flat monitors between 17 and 32 inches (43-81 cm) up to 9 kg each

- Perfect for the stable desk mounting of two screens up to 9 kg each, freely height-adjustable, swivelling and tilting
- Thanks to the gas spring, you can easily bring the monitors into the ideal, ergonomic position at any time without any effort - whether for working, gaming or video calls



58531 Retail Box

RRP 49.99 €

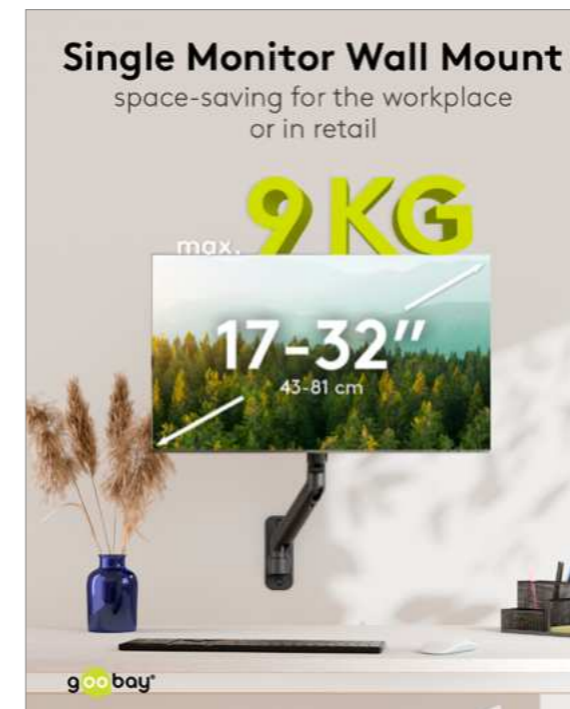

### Goobay

#### Single Monitor Wall Mount

for monitors from 17 to 32 inches (43 - 81 cm), max. 9 kg, for wall mounting

- The robust metal wall mount is the space-saving solution for monitors - wherever there is no table or insufficient space
- Handy solution for the workstation in the office or mobile office, but also for POS applications in retail and for attaching information monitors
- Perfect for stable desk mounting of a screen up to 9 kg, height adjustable,  $\pm 90^\circ$  swivelling and  $\pm 90^\circ$  tilting,  $180^\circ$  rotation
- Thanks to the mechanical spring with flexible pressure level, you can easily bring the monitor into the ideal, ergonomic position at any time without any effort - whether for working, gaming or video calls



70820 Brown Box

RRP 39.99 €

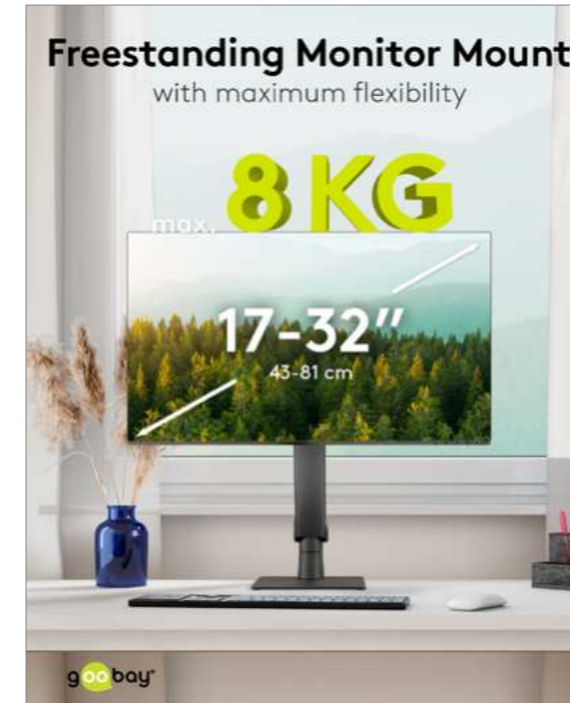

### Goobay Basic

#### Freestanding Single Monitor Mount

for monitors from 17 to 32 inches (43 - 81 cm), max. 8 kg, fully flexible table stand

- In contrast to conventional, static monitor stands, this model can be flexibly adjusted in order to freely tilt and swivel the monitor
- The free-standing monitor stand can be easily transported if required - without the need for time-consuming unscrewing from the table top and subsequent reattachment
- Perfect as a stable table mount for a screen weighing up to 8kg, height-adjustable,  $\pm 25^\circ$  swivelling and  $+10/-15^\circ$  tilting,  $180^\circ$  rotation
- Thanks to the gas spring with flexible pressure level, you can easily bring the monitor into the ideal, ergonomic position at any time without any effort - whether for working, gaming or video calls



70821 Brown Box

RRP 59.99 €

# The Pro Series

for the professional sector

**Detachable VESA Plate**  
for quick attachment  
and detachment

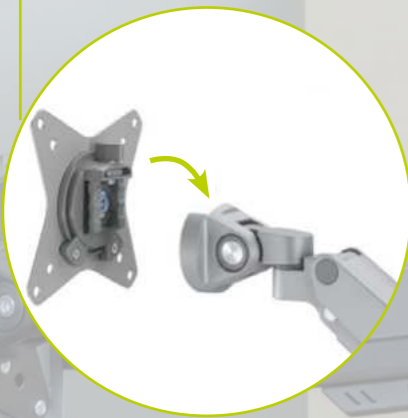

**With Gas Spring Power**  
Individually adjustable when  
mounted



**Topside Installation**  
no more crawling under desks, clamp  
and grommet options included



**Quick-Release Joint**  
for easy user assembly while reducing  
packaging size (perfect for e-commerce  
platform sellers)



Quick and easy installation  
Metal arm for a long service life  
Fully adjustable when mounted



## The Pro Series

With its slim base, the robust metal monitor stand is the space-saving solution for the desk in the office or at home.

- User-friendly installation thanks to the easy-access screw on the top of the base, without in-convenient attachment under the table and without moving heavy tables away from the wall
- Thanks to the gas spring with adjustable pressure level, you can easily bring the monitor into the ideal, ergonomic position at any time without any effort - whether for working, gaming or video calls
- The compact stand creates additional space on the desk and ensures a clean look with the integrated cable management system.
- The monitor mount is compatible with the VESA® standards 75x75 mm and 100x100 mm



Goobay Pro

### Single Monitor Mount with Gas Spring

for monitors from 17 to 32 inches (43 - 81 cm), max. 9 kg, easy snap-in mounting of the arms

- Perfect for stable table mounting of a screen up to 9 kg, height-adjustable,  $\pm 90^\circ$  swivelling and  $\pm 45^\circ$  tilting,  $180^\circ$  rotation, recommended table top thickness: 10-50 mm



70813 Brown Box RRP 59.99 €

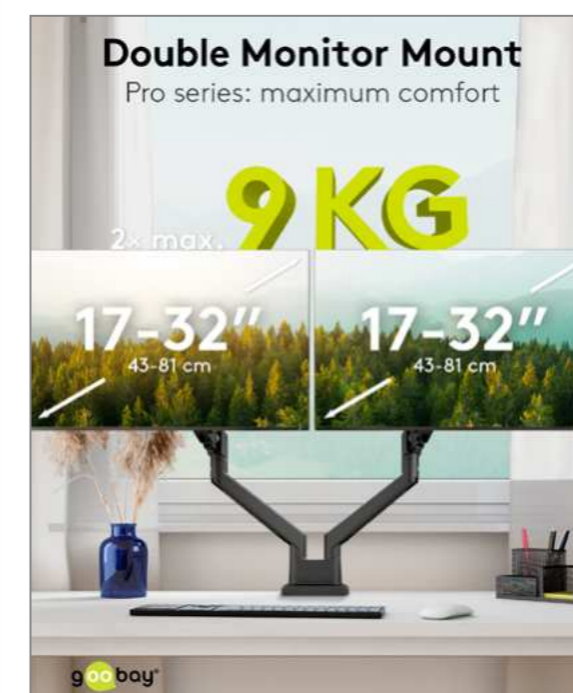

Goobay Pro

### Dual Monitor Mount with Gas Spring

for monitors from 17 to 32 inches (43 - 81 cm), max. 9 kg per monitor, easy snap-in mounting of the arms

- Perfect for stable table mounting of two screens up to 9 kg each, height-adjustable,  $\pm 90^\circ$  swivelling and  $\pm 45^\circ$  tilting,  $180^\circ$  rotation, recommended tabletop thickness: 10-50 mm



70814 Brown Box RRP 99.99 €



## Workstation

Flexible monitor mount with shelf for a mobile laptop, which can be used as a second monitor in the office and taken to meetings at any time.



### Goobay

#### Monitor Mount with Laptop Arm Flex

workstation for monitors from 13 to 32 inches (33 - 81 cm) plus a laptop, monitor max. 8 kg/laptop 4.5 kg

- Perfect for stable table mounting of a screen up to 8 kg and a laptop up to 4.5 kg, height-adjustable,  $\pm 90^\circ$  swivelling and  $\pm 45^\circ$  tilting, 180° rotation, recommended tabletop thickness: 10-88 mm
- With the slim base, the robust monitor stand is the space-saving solution for the desk at home or in the office
- With ventilation slots for effective air circulation, the laptop stand prevents potential heat build-up under the device
- The integrated cable management system of the monitor arm protects the cables and creates a clean look without cable clutter



70815 Brown Box RRP 49.99 €



### Goobay Pro

#### Deluxe Monitor Mount with Laptop Arm

workstation for monitors from 17 to 32 inches (43 - 81 cm) plus a laptop, monitor max. 8 kg/laptop 5 kg, easy snap-in mounting of the arms

- The Pro series for the professional sector: Robust monitor holder with shelf for a mobile laptop that can be used as a second monitor in the office and taken to meetings at any time
- Perfect for stable table mounting of a screen up to 8 kg and a laptop up to 5 kg, height-adjustable,  $\pm 90^\circ$  swivelling and  $+90^\circ/-30^\circ$  tilting, 180° rotation, recommended tabletop thickness: 10-80 mm
- The padded clamping jaws can be flexibly adjusted to the size of the laptop and ensure a secure hold



74417 Brown Box RRP 99.99 €



## Laptop Mount

Perfect as a stand for a mobile laptop that can be used as a main or second monitor in the office and can be taken along to meetings at any time. Universally suitable, it can be mounted on any Goobay monitor mount.

- Practical, robust metal laptop mount for monitor arms with VESA®-compatible mounting plates
- With ventilation slots for effective air circulation, the laptop stand prevents potential heat build-up under the device
- The laptop mount is compatible with the VESA® standards 75x75 mm and 100x100 mm



### Goobay Basic

#### Laptop Mount for Monitor Arm

for monitors from 10 to 15.6 inches (25 - 40 cm), max. 4.5 kg, for mounting on a monitor mount

- Adjustable clamping jaws on the side to hold the device firmly and securely in position
- With ventilation slots for effective air circulation, the laptop stand prevents potential heat build-up under the device
- Suitable as a replacement or addition to a dual monitor mount



70817 Brown Box RRP 14.99 €

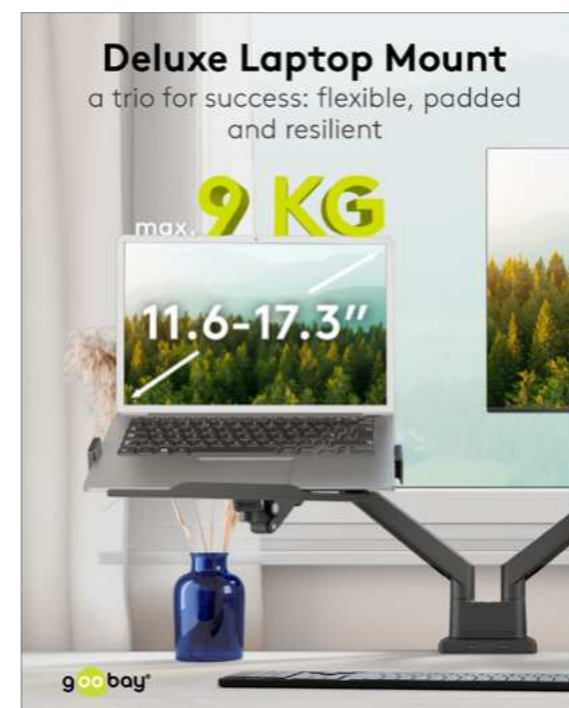

### Goobay Basic

#### Deluxe Laptop Mount for Monitor Arm

for monitors from 11.6 to 17.3 inches (29 - 44 cm), max. 9 kg, for mounting on a monitor mount

- Padded clamping jaws with spring mechanism to hold the laptop firmly and securely in position without scratching or damaging the device
- Suitable as a replacement or addition to a dual monitor mount



70818 Brown Box RRP 19.99 €



### Gaming & Business Curved XL

Heavy-duty monitor mount for the safe handling of XL monitors in the gaming and office sector: with its slim base, the robust metal monitor stand is the space-saving solution for the desk.



#### Goobay Basic

#### Single Monitor Mount with Gas Spring

for XL monitors from 17 to 49 inches (43 - 124 cm), max. 20 kg, tailored to large and heavy gaming and business monitors

- Thanks to the gas spring with flexible pressure level, you can easily bring the monitor into the ideal, ergonomic position at any time without any effort - whether for working, gaming or video calls
- User-friendly installation thanks to the easy-access screw on the top of the base, without inconvenient attachment under the table and without moving heavy tables away from the wall
- Perfect for stable table mounting of a screen up to 20 kg, heightadjustable, ±90° swivelling and +50°/-20° tilting, 180° rotation, recommended tabletop thickness: 12-50 mm
- Installation is quick and easy with the included mounting material, either using a screw with drill hole or a table clamp that can be removed without leaving any residue
- Incl. removable, VESA®-compatible mounting plate for easy replacement of individual monitors without tools
- The monitor mount is compatible with the VESA® standards 75x75 mm and 100x100 mm

74416 Brown Box RRP 89.99 €



### TV Mounts



FIXED



TILT



FULLMOTION



Universal



Accessories



Ceiling Mount



Floor stands & feet

### TV MOUNTS

CREATE A CINEMATIC EXPERIENCE WITH YOUR TV

FULLY FLEXIBLY ALIGNED, OUR MOUNTS ENSURE COMPLETE IMMERSION AND PERFECT VIEWING ANGLES FOR DISCOVERING NEW WORLDS



## TV Wall Mount – Clear Product Range Structure

FIXED

TILT

FULL MOTION

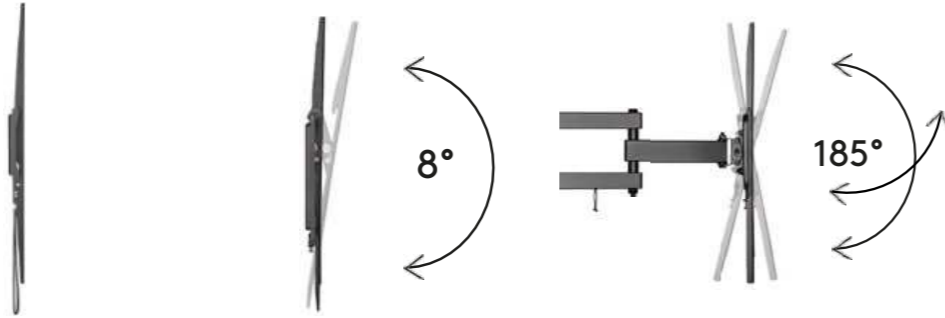

3  
TYPES

### BASIC SERIES

### PRO SERIES



FUNCTIONAL



HIGH PERFORMANCE  
SMART FEATURES

2  
SERIES





## The FIXED Basic Series

With the minimalist FIXED series, you can mount your TV on the wall – ultra-flat and completely reliably. The TV mounts ensure a harmonious room appearance and a clean finish with minimal wall clearance.



### Goobay Basic

#### TV Wall Mount Basic FIXED (Size S)

for TV sets and monitors from 23 to 42 inch (58-107 cm), up to 25 kg

- attaches the TV in a fixed position only 15 mm from the wall
- perfect for small TV sets in niches or above wall units such as in the kit
- suitable for TV sets of common sizes (e. g. 24 inch, 27 inch, 32 inch, 40 inch) and brands (Samsung, Sony, Philips, LG etc.) with QLED and LED
- easy mounting, compatible with VESA standards 75x75 and 100x100



58523 Retail Box RRP 9.99 €



### Goobay Basic

#### TV wall mount Basic FIXED (M)

for TVs from 32 to 55 inch (81-140 cm), up to 35 kg

- The extremely flat wall mount keeps the TV elegantly flat and space-saving on the wall with only 20.5 mm.
- The open frame structure supports ventilation of the TV and allows access to the rear connections.
- Suitable wall bracket for most flat and curved televisions of all popular brands (e. g. Samsung (also QLED and LED), Sony, Philips, LG) and sizes (e. g. 32 inch, 40 inch, 43 inch, 49 inch, 50 inch, 55 inch)
- Easy mounting and compatible with VESA standards 200x200, 300x300, 400x200, 400x400.



49730 Retail Box RRP 14.99 €



### Goobay Basic

#### TV wall mount Basic FIXED (L)

for TVs from 37 to 70 inch (94-178 cm), up to 35 kg

- The extremely flat wall mount keeps the TV elegantly flat and space-saving on the wall with only 20.5 mm.
- The open frame structure supports ventilation of the TV and allows access to the rear connections.
- Suitable wall bracket for most flat and curved TVs of all popular brands (e. g. Samsung (also QLED and LED), Sony, Philips, LG) and sizes (e. g. 40 inch, 43 inch, 49 inch, 50 inch, 55 inch, 58 inch, 65 inch)
- Easy mounting and compatible with VESA standards 200x200, 300x300, 400x200, 400x400, 600x400.

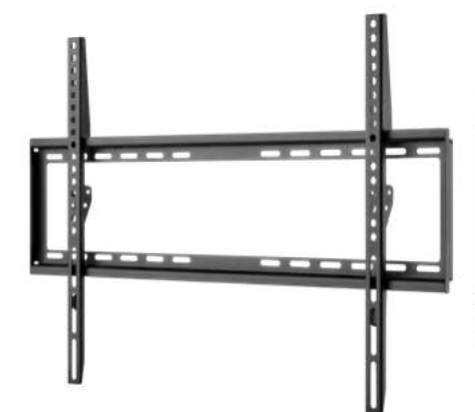

49732 Retail Box RRP 19.99 €



### Goobay Basic

#### TV wall mount Basic FIXED (XL)

for TVs from 43 to 100 inch (109-254 cm), up to 75 kg

- The extremely flat wall mount keeps the TV elegantly flat and space-saving on the wall with only 30 mm.
- The open frame structure supports ventilation of the TV and allows access to the rear connections.
- The integrated spirit level ensures easy alignment of the installation.
- The TV wall bracket is suitable for most curved and flat screen TVs of popular brands, e.g. Samsung (QLED and LED), Sony, Philips and LG, as well as for many sizes (e.g. 50 inch, 55 inch, 58 inch, 65 inch, 75 inch, 85 inch)
- Easy mounting and compatible with VESA standards 200x200, 300x300, 400x200, 400x400, 600x400, 800x400.



49742 Retail Box RRP 24.99 €



Goobay Basic

Ultraslim TV Wall Mount Basic FIXED (XL)

mount for TVs from 43 to 100 inches (109–254 cm), max. 75 kg, ultra-flat design with 9.5 mm wall distance

- Perfect for particularly large and heavy TV sets up to 100 inches (254 cm) and 75 kg, which can be easily and quickly attached using snap-on mounting
- For precise installation and alignment, the crossbar has convenient, VESA®-compatible distance markings and a built-in spirit level
- The suspension brackets are laterally adjustable and therefore easy to align with the VESA®-compatible markings
- The supplied support can be wedged between the appliance and the wall as required, creating space to simplify the process of connecting cables
- The TV wall bracket is suitable for most curved and flat screen TVs from popular brands, e.g. Samsung (QLED and LED), Sony, Philips and LG as well as many sizes, e.g. 50 inch, 55 inch, 58 inch, 65 inch, 75 inch, 85 inch
- Compatible with VESA® standards 200x200 mm, 300x200 mm, 400x200 mm, 300x300 mm, 400x300 mm, 400x400 mm, 600x400 mm, 800x400 mm, 800x600 mm



70822 Brown Box RRP 49.99 €

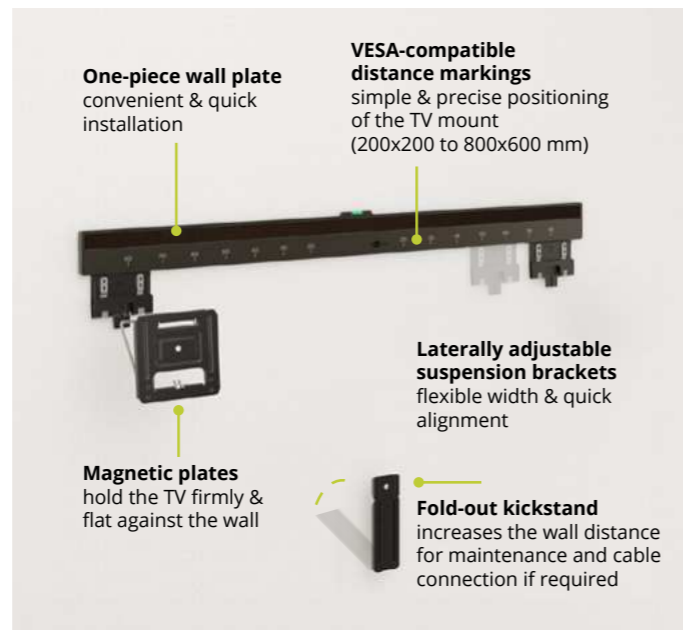
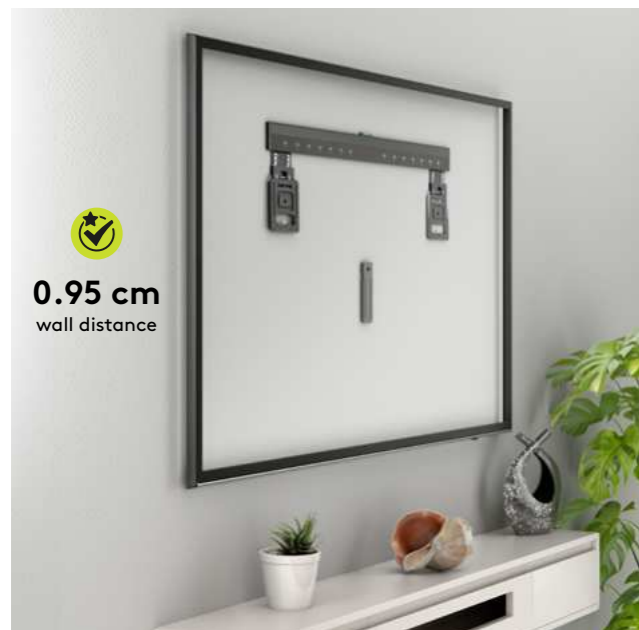

Goobay OLED

TV wall mount OLED FIXED (L)

especially for OLED TVs from 37 to 70 inch (94-178 cm), up to 50 kg



- The extremely flat wall mount keeps the TV elegantly flat and space-saving on the wall with only 17 mm.
- Installation is getting easy by the innovative slide-in design and easy access to the mounted cabling.
- Easy mounting and compatible with VESA standards 200x100, 200x200, 300x200, 300x300, 400x200, 400x300, 400x400, 600x400.

49949 Retail Box RRP 24.99 €



### The FIXED Pro Series

The perfect solution for anyone who needs a fixed viewing angle on their TV – in the living room, bedroom or office. With the spring lock that automatically engages and the handy hand strap, installing any flat-screen TV becomes super easy.

- **Automatic Click-in & Easy Release**  
The mounting aid with spring lock for secure snap-in and release when hanging up the TV (no locking screws that have to be fixed manually) makes installation child's play.
- **The integrated spirit level ensures easy alignment of the installation.**

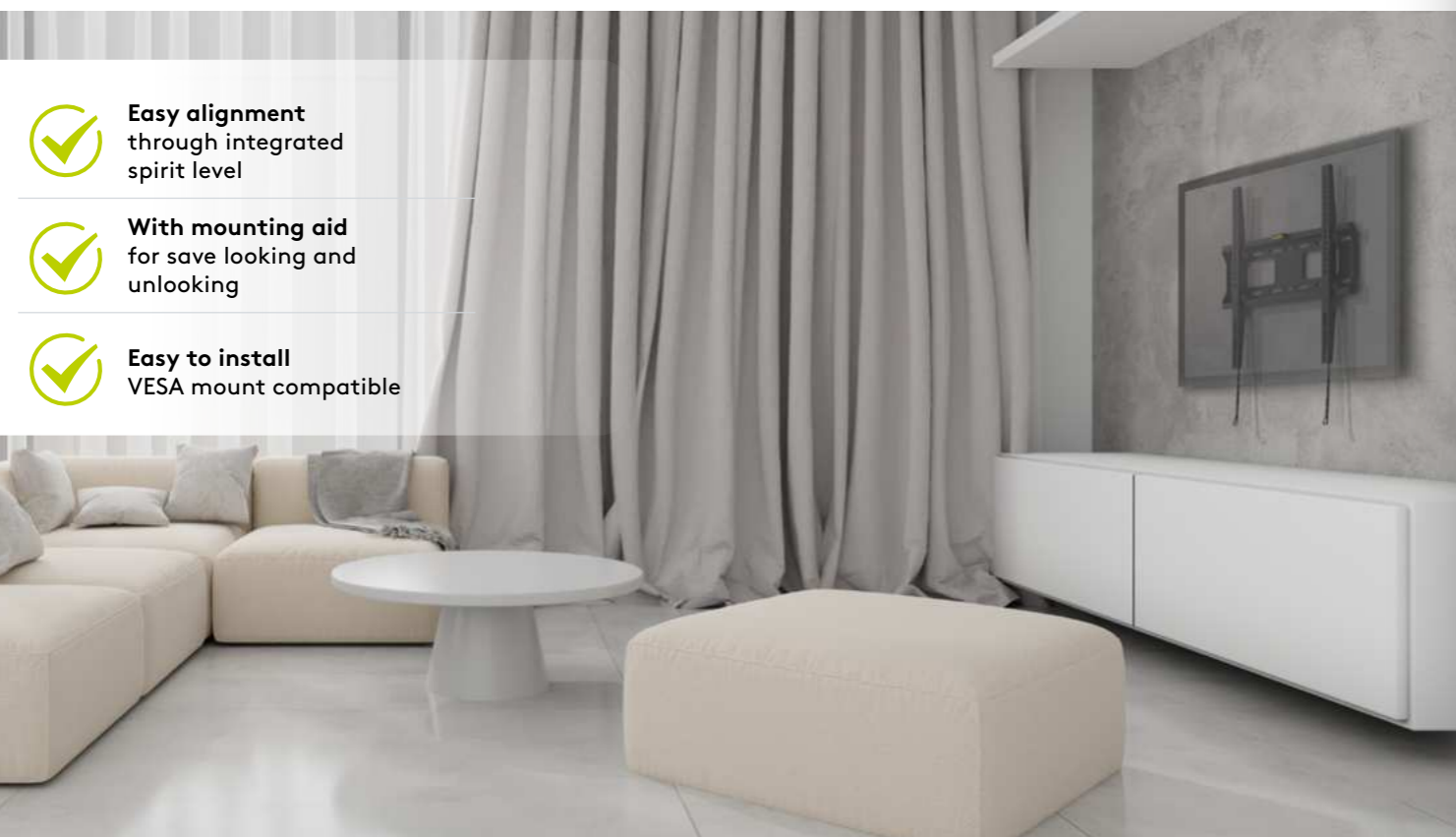
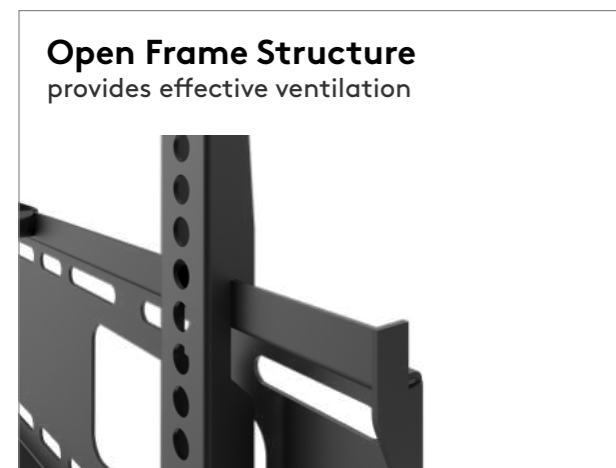

- ✓ **Easy alignment**  
through integrated spirit level
- ✓ **With mounting aid**  
for save looking and unloading
- ✓ **Easy to install**  
VESA mount compatible

### Goobay Pro

#### TV wall mount Pro FIXED (M)

for TVs from 32 to 55 inch (81-140 cm), up to 50 kg



- The extremely flat wall mount keeps the TV elegantly flat and space-saving on the wall with only 25 mm.
- The TV wall bracket is suitable for most curved and flat screen TVs of popular brands, e.g. Samsung (QLED and LED), Sony, Philips and LG, as well as for many sizes (e.g. 32 inch, 40 inch, 43 inch, 49 inch, 50 inch, 55 inch)
- Easy mounting and compatible with VESA standards 200x200, 300x300, 400x200, 400x400.

49890 Retail Box RRP 24.99 €



### Goobay Pro

#### TV wall mount Pro FIXED (L)

for TV sets from 37 to 70 inch (94-178 cm), up to 50 kg

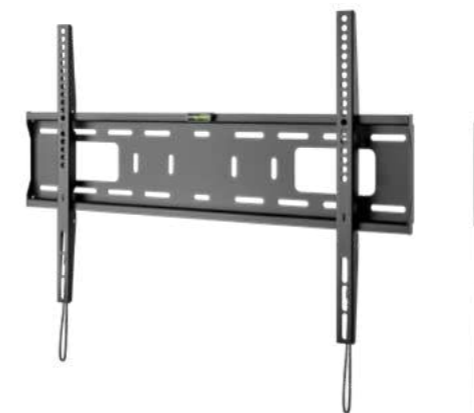

- The extremely flat wall mount keeps the TV elegantly flat and space-saving on the wall with only 25 mm.
- The TV wall bracket is suitable for most curved and flat screen TVs of popular brands, e.g. Samsung (QLED and LED), Sony, Philips and LG, as well as for many sizes (e.g. 40 inch, 43 inch, 49 inch, 50 inch, 55 inch, 58 inch, 65 inch)
- Easy mounting and compatible with VESA standards 200x200, 300x300, 400x200, 400x400, 600x400.

49891 Retail Box RRP 29.99 €



### Goobay Pro

#### TV wall mount Pro FIXED (XL)

for TVs from 43 to 100 inch (109-254 cm), up to 75 kg



- The extremely flat wall mount keeps the TV elegantly flat and space-saving on the wall with only 30.5 mm.
- The TV wall bracket is suitable for most curved and flat screen TVs of popular brands, e.g. Samsung (QLED and LED), Sony, Philips and LG, as well as for many sizes (e.g. 50 inch, 55 inch, 58 inch, 65 inch, 75 inch, 85 inch).
- Easy mounting and compatible with VESA standards 200x200, 300x300, 400x200, 400x300, 400x400, 600x400, 600x600, 800x600, 900x600.

49892 Retail Box RRP 34.99 €



### The TILT Basic Series

The perfect solution for anyone who needs a fixed viewing angle on the TV – in the living room, bedroom or office. The TV mounts in the TILT series can be adjusted to a fixed tilt angle for added convenience.

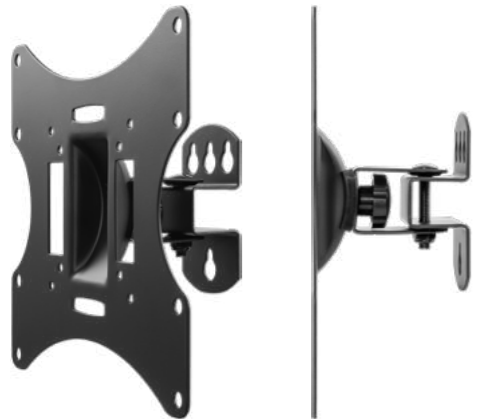

#### Goobay Basic

#### TV Wall Mount Basic TILT (Size S)

for TVs and monitors from 23 to 42 inch (58-107 cm), tilt and swivel

- practical, space-saving solution to mount TV sets of up to 30 kg while retaining full flexibility
- only 9 cm deep, the item is perfect for small TV sets in niches or above wall units such as in the kitchen or bedroom
- suitable for most TV sets of common sizes (e. g. 24 inch, 27 inch, 32 inch, 40 inch) and brands (Samsung, Sony, Philips, LG etc.) with QLED and LED
- easy mounting, compatible with VESA standards 75x75, 100x100, 200x100, 200x200



51893 Retail Box RRP 14.99 €

- ✓ **For Small TVs**  
In corners or above wall units
- ✓ **Tilt and Swivel**  
For an ideal viewing position
- ✓ **Suitable for**  
TV sets of current sizes and brands
- ✓ **Easy to install**  
VESA mount compatible

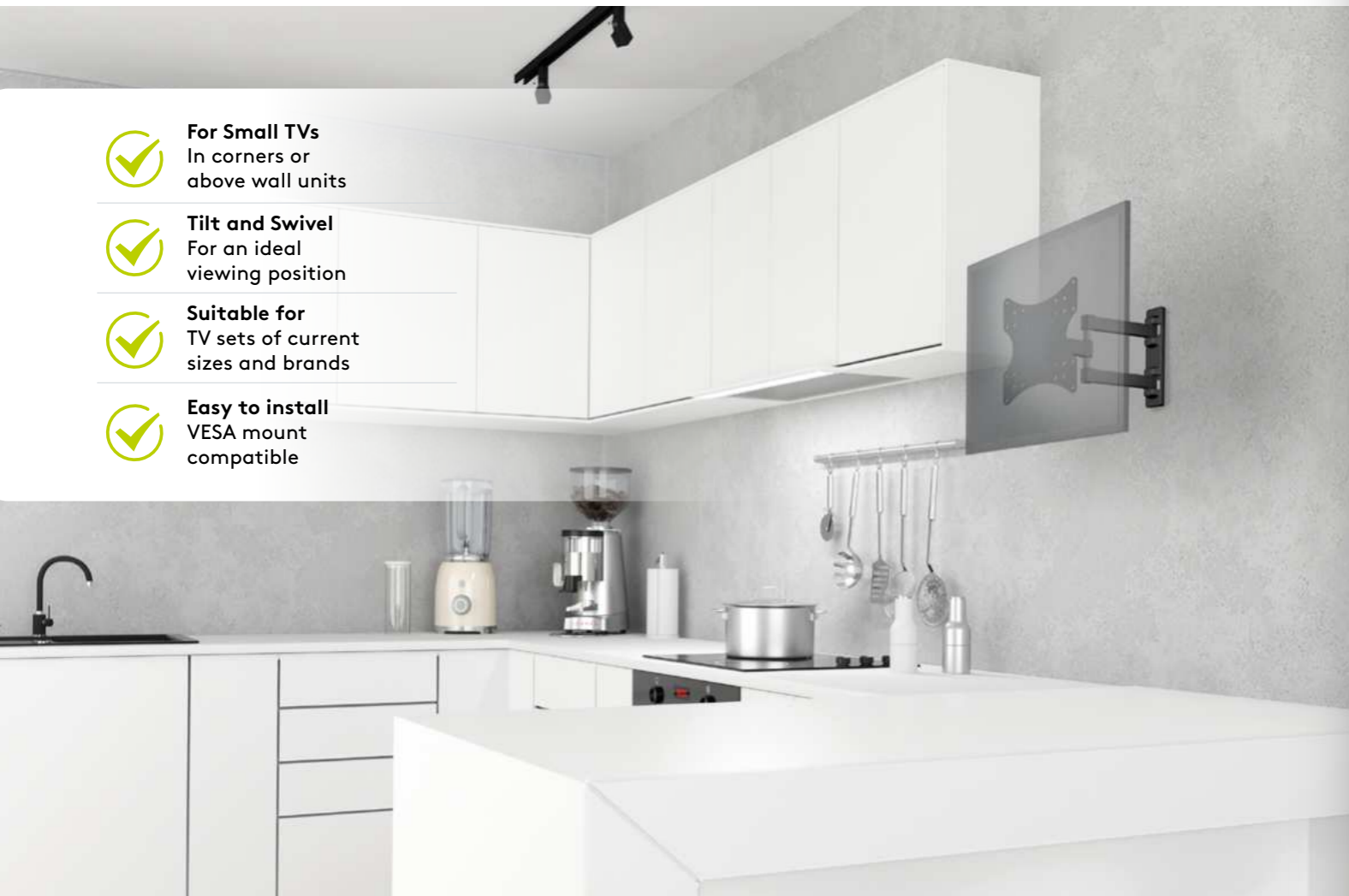

- The open frame structure supports ventilation of the TV and allows access to the rear connections.

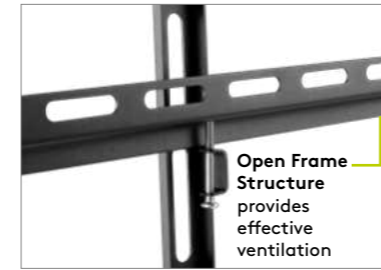

Open Frame Structure provides effective ventilation



TV Wall Mount precise fastening by tommy screw

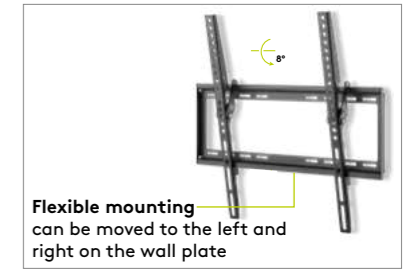

Flexible mounting can be moved to the left and right on the wall plate

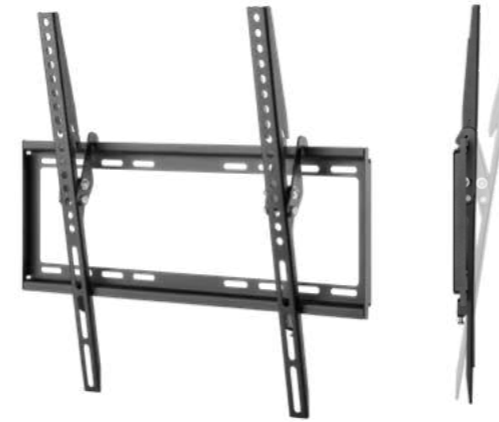

#### Goobay Basic

#### TV wall mount Basic TILT (M)

for TVs from 32 to 55 inch (81-140 cm), tiltable, up to 35 kg

- The flat wall mount keeps the TV elegantly flat and space-saving on the wall with only 20.5 mm and can also be tilted up to 8°.
- Suitable wall bracket for most flat and curved televisions of all popular brands (e. g. Samsung (also QLED and LED), Sony, Philips, LG) and sizes (e. g. 32 inch, 40 inch, 43 inch, 49 inch, 50 inch, 55 inch)
- Easy mounting and compatible with VESA standards 200x200, 300x300, 400x200, 400x400.



49731 Retail Box RRP 19.99 €



#### Goobay Basic

#### TV wall mount Basic TILT (L)

for TVs from 37 to 70 inch (94-178 cm), tiltable, up to 35 kg

- The flat wall mount keeps the TV elegantly flat and space-saving on the wall with only 20.5 mm and can also be tilted up to 8°.
- Suitable wall bracket for most flat and curved TVs of all popular brands (e. g. Samsung (also QLED and LED), Sony, Philips, LG) and sizes (e. g. 40 inch, 43 inch, 49 inch, 50 inch, 55 inch, 58 inch, 65 inch)
- Easy mounting and compatible with VESA standards 200x200, 300x300, 400x200, 400x400, 600x400.



49741 Retail Box RRP 24.99 €



#### Goobay Basic

#### TV wall mount Basic TILT (XL)

for TVs from 43 to 100 inch (109-254 cm), tiltable, up to 75 kg

- The flat wall mount keeps the TV elegantly flat and space-saving on the wall with only 45 mm and can also be tilted up to 10°.
- The integrated spirit level ensures easy alignment of the installation.
- The TV wall bracket is suitable for most curved and flat screen TVs of popular brands, e.g. Samsung (QLED and LED), Sony, Philips and LG, as well as for many sizes (e.g. 50 inch, 55 inch, 58 inch, 65 inch, 75 inch, 85 inch)
- Easy mounting and compatible with VESA standards 200x200, 300x300, 400x200, 400x400, 600x400, 800x400.







49743 Retail Box RRP 29.99 €

### The TILT Pro Series

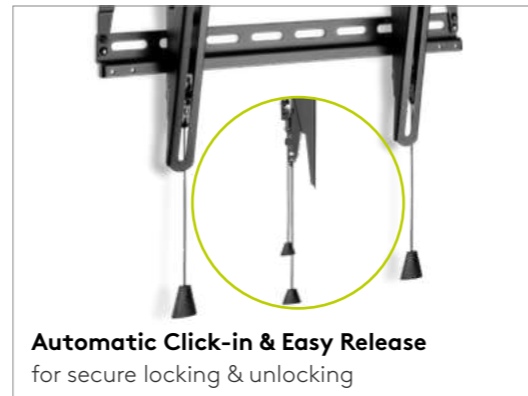
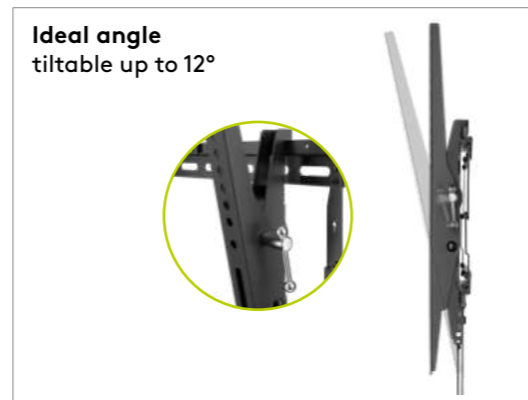
The perfect solution for anyone who needs a fixed viewing angle of the TV – in the living room, bedroom or office. The TV mounts in the TILT series can be adjusted to a fixed tilt angle for added convenience. With the automatic spring lock and the handy hand strap, installing any flat-screen TV becomes super easy.

- The flat wall mount keeps the TV elegantly flat and space-saving on the wall with only 49 mm and can also be tilted up to 12°.
- Automatic Click-in & Easy Release - The mounting aid with spring lock for secure snap-in and release when hanging up the TV (no locking screws that have to be fixed manually) makes installation child's play.
- The integrated spirit level ensures easy alignment of the installation.



-  **Easy alignment** through integrated spirit level
-  **With mounting aid** for save locking and releasing
-  **Easy to install** VESA mount compatible



### Goobay Pro TV wall mount Pro TILT (M)

for TVs from 32 to 55 inch (81-140 cm), up to 70 kg

- The TV wall bracket is suitable for most curved and flat screen TVs of popular brands, e.g. Samsung (QLED and LED), Sony, Philips and LG, as well as for many sizes (e.g. 32 inch, 40 inch, 43 inch, 49 inch, 50 inch, 55 inch)
- Easy mounting and compatible with VESA standards 75x75, 100x100, 100x150, 150x100, 150x150, 200x100, 100x200, 200x200, 300x200, 300x300, 400x200, 400x300, 400x400.

49909 Retail Box RRP 29.99 €



### Goobay Pro TV wall mount Pro TILT (L)

for TVs from 37 to 70 inch (94-178 cm), tiltable, up to 70 kg

- The TV wall bracket is suitable for most curved and flat screen TVs of popular brands, e.g. Samsung (QLED and LED), Sony, Philips and LG, as well as for many sizes (e.g. 40 inch, 43 inch, 49 inch, 50 inch, 55 inch, 58 inch, 65 inch)
- Easy mounting and compatible with VESA standards 200x200, 300x200, 300x300, 400x200, 400x300, 400x400, 600x400.

49929 Retail Box RRP 34.99 €



### Goobay Pro TV wall mount Pro TILT (XL)

for TVs from 43 to 100 inch (109-254 cm), tiltable, up to 70 kg

- The TV wall bracket is suitable for most curved and flat screen TVs of popular brands, e.g. Samsung (QLED and LED), Sony, Philips and LG, as well as for many sizes (e.g. 50 inch, 55 inch, 58 inch, 65 inch, 75 inch, 85 inch)
- Easy mounting and compatible with VESA standards 200x200, 300x200, 300x300, 400x200, 400x300, 400x400, 600x400, 800x400.

49930 Retail Box RRP 39.99 €



## The FULLMOTION Basic Series

Fullmotion stands for full flexibility: Tilting, swivelling, extending and adjusting is possible completely toolless. The versatile product range includes mounts for small devices in niches or wall units, as well as mounts for larger TVs that need to be individually re-aligned every now and then.

### Goobay Basic

#### TV wall mount Basic FULLMOTION (S)

for TVs from 23 to 42 inch (58-107cm), fully mobile (swivel and tilt), up to 20 kg



- Perfect viewing angle and maximum flexibility through full mobility in tilt (up/down from +3° to -10°) and swivel (left/right by ±90°)
- The wall mount keeps the TV in the position with only 44 mm elegantly flat and space-saving on the wall and can be extended up to 192 mm to achieve the optimal viewing angle.
- The TV wall bracket is suitable for most TV sets of popular brands, e.g. Samsung (QLED and LED), Sony, Philips and LG, as well as for many sizes (e.g. 24 inch, 27 inch, 32 inch, 40 inch)
- Easy mounting and compatible with VESA standards 75x75, 100x100, 100x150, 150x100, 150x150, 200x100, 200x200.

49713 Retail Box RRP 14.99 €



### Goobay Basic

#### TV wall mount Basic FULLMOTION (S)

for TVs from 23 to 42 inch (58-107cm), fully movable double arm joint (swivel and tilt), up to 15 kg

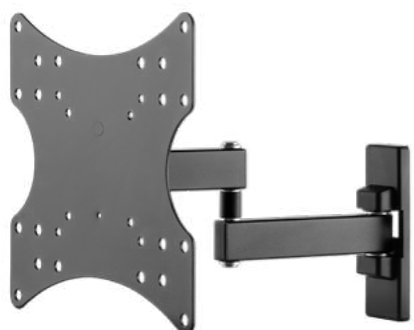

- Perfect viewing angle and maximum flexibility through full mobility in tilt (up/down from +3° to -10°) and swivel (left/right by ±90°)
- The wall mount keeps the TV in the position with only 44 mm elegantly flat and space-saving on the wall and can be extended up to 282 mm to achieve the optimal viewing angle.
- The TV wall bracket is suitable for most TV sets of popular brands, e.g. Samsung (QLED and LED), Sony, Philips and LG, as well as for many sizes (e.g. 24 inch, 27 inch, 32 inch, 40 inch)
- Easy mounting and compatible with VESA standards 75x75, 100x100, 100x150, 150x100, 150x150, 200x100, 200x200.

49714 Retail Box RRP 19.99 €



### Goobay Basic

#### TV wall mount Basic FULLMOTION (S)

for TVs from 23 to 42 inch (58-107cm), fully movable double arm joint (swivel and tilt), up to 20 kg

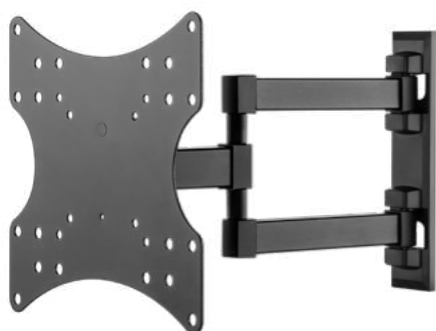

- Perfect viewing angle and maximum flexibility through full mobility in tilt (up/down from +3° to -10°) and swivel (left/right by ±90°)
- The wall mount keeps the TV in the position with only 44 mm elegantly flat and space-saving on the wall and can be extended up to 320 mm to achieve the optimal viewing angle.
- The TV wall bracket is suitable for most TV sets of popular brands, e.g. Samsung (QLED and LED), Sony, Philips and LG, as well as for many sizes (e.g. 24 inch, 27 inch, 32 inch, 40 inch)
- Easy mounting and compatible with VESA standards 75x75, 100x100, 100x150, 150x100, 150x150, 200x100, 200x200.

49715 Retail Box RRP 19.99 €



### Goobay Basic

#### TV wall mount Basic FULLMOTION (M)

for TVs from 32 to 55 inch (81-140 cm), fully mobile (swivel and tilt), up to 35 kg

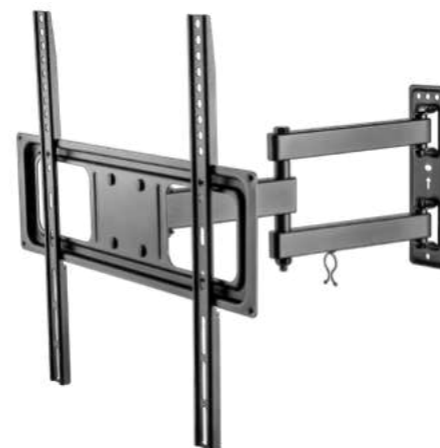

- Perfect viewing angle and maximum flexibility through full mobility in tilt (up/down from +10° to -15°) and swivel (left/right by ±90°)
- The wall mount keeps the TV in the position with only 63mm elegantly flat and space-saving on the wall and can be extended up to 427 mm to achieve the optimal viewing angle.
- The integrated cable management system ensures order and protection of the connection cables.
- The TV wall bracket is suitable for most curved and flat screen TVs of popular brands, e.g. Samsung (QLED and LED), Sony, Philips and LG, as well as for many sizes (e.g. 32 inch, 40 inch, 43 inch, 49 inch, 50 inch, 55 inch)
- Easy mounting and compatible with VESA standards 200x200, 300x300, 400x200, 400x400.

49744 Retail Box RRP 39.99 €



- ✓ **Maximum Flexibility**  
full-motion, tilt & swivel properties
- ✓ **For a clean look**  
integrated cable management system
- ✓ **Easy to install**  
VESA mount compatible

### Goobay Basic

#### TV wall mount Basic FULLMOTION (L)

for TVs from 37 to 70 inch (94-178 cm), fully mobile (swivel and tilt), up to 35 kg



- Perfect viewing angle and maximum flexibility through full mobility in tilt (up/down from +10° to -15°) and swivel (left/right by ±90°)
- The wall mount keeps the TV in the position with only 63mm elegantly flat and space-saving on the wall and can be extended up to 427 mm to achieve the optimal viewing angle.
- The integrated cable management system ensures order and protection of the connection cables.
- The TV wall bracket is suitable for most curved and flat screen TVs of popular brands, e.g. Samsung (QLED and LED), Sony, Philips and LG, as well as for many sizes (e.g. 40 inch, 43 inch, 49 inch, 50 inch, 55 inch, 58 inch, 65 inch)
- Easy mounting and compatible with VESA standards 200x200, 300x300, 400x200, 400x400, 600x400.

49745 Retail Box RRP 49.99 €





### Goobay Basic

#### TV Wall Mount Basic FULLMOTION (L)

mount for TVs from 37 to 80 inches (94–203 cm), max. 45 kg, fully flexible: swivels and tilts

- Maximum flexible TV mount for an optimised viewing angle: +3/-12° tiltable (up/down), +60/-60° swivelling (left/right), 47.5 cm extendable
- For a discreet room appearance, the mount achieves a minimum wall clearance of 5.5 cm so that the TV does not protrude/extend into the room
- The integrated cable management system protects the connection cables and ensures a clean look without cable clutter
- The TV wall bracket is suitable for most curved and flat screen TVs from popular brands, e.g. Samsung (QLED and LED), Sony, Philips and LG as well as many sizes, e.g. 50 inch, 55 inch, 58 inch, 65 inch, 75 inch
- Compatible with VESA® standards 200x200 mm, 200x300 mm, 300x200 mm, 200x400 mm, 400x200 mm, 300x300 mm, 300x400 mm, 400x300 mm, 600x200 mm, 400x400 mm, 600x300 mm, 600x400 mm



71199 Brown Box RRP 49.99 €



### Goobay OLED

#### TV wall mount OLED FULLMOTION (L)

especially for OLED TVs from 37 to 70 inch (94-178 cm), fully movable (swivel and tilt), up to 30 kg

- Perfect viewing angle and maximum flexibility through full mobility in tilt (up/down from +5° to -8°) and swivel (left/right by ±60°)
- The wall mount keeps the TV in the position with only 50 mm elegantly flat and space-saving on the wall and can be extended up to 510 mm to achieve the optimal viewing angle.
- Adjustable scissor arm joint supports the extension and stabilizes the movement.
- The removable VESA-compatible plate allows for a quick and easy installation.
- The wall bracket is suitable for most curved and flat screen TVs of popular brands, e.g. Samsung (QLED and LED), Sony, Philips and LG, as well as for many sizes (e.g. 40 inch, 43 inch, 49 inch, 50 inch, 55 inch, 58 inch, 65 inch).
- Easy mounting and compatible with VESA standards 100x100, 100x150, 150x100, 150x150, 200x100, 100x200, 200x200, 300x200, 400x200.



49956 Retail Box RRP 89.99 €



## The FULLMOTION Pro Series

The Pro Series stands for full flexibility and maximum sturdiness: Tilting, swivelling, extending and adjusting is possible completely toolless. Cleverly designed for extra stability, our mounts are specially tailored for large, heavy TVs.



### Goobay Pro

#### TV wall mount Pro FULLMOTION (L)

for TVs from 37 to 70 inch (94-178 cm), fully mobile (swivel and tilt), up to 60 kg

- Perfect viewing angle and maximum flexibility through full mobility in tilt (up/down from +3° to -15°) and swivel (left/right by ±60°)
- The wall mount keeps the TV in the position with only 77 mm elegantly flat and space-saving on the wall and can be extended up to 428mm to achieve the optimal viewing angle.
- Adjustable scissor arm joint supports the extension and stabilizes the movement.
- The wall bracket is suitable for most curved and flat screen TVs of popular brands, e.g. Samsung (QLED and LED), Sony, Philips and LG, as well as for many sizes (e.g. 40 inch, 43 inch, 49 inch, 50 inch, 55 inch, 58 inch, 65 inch).
- Easy mounting and compatible with VESA standards 200x200, 300x200, 300x300, 400x200, 400x300, 400x400, 600x400.



49932 Retail Box RRP 89.99 €



### Goobay Pro

#### TV Wall Mount Pro FULLMOTION (XL)

mount for TVs from 43 to 90 inches (109–229 cm), max. 60 kg, fully flexible: swivels, tilts, sideways adjustable

- Maximum flexible TV mount for an optimised viewing angle: +5/-10° tiltable (up/down), +60/-60° swivelling (left/right), 53.6 cm extendable
- Easy to install: In a first step, attach the mounting rail to the monitor, in a second step, hook the rail into the TV mount
- The scissor joint can be moved sideways along the wall mounting, allowing more flexible alignment of the TV than conventional mounts
- The TV wall bracket is suitable for most curved and flat screen TVs from popular brands, e.g. Samsung (QLED and LED), Sony, Philips and LG as well as many sizes, e.g. 50 inch, 55 inch, 58 inch, 65 inch, 75 inch, 85 inch
- Compatible with VESA® standards 200x100 mm, 200x200 mm, 300x200 mm, 400x200 mm, 300x300 mm, 400x300 mm, 400x400 mm, 600x400 mm, 800x400 mm



71216 Brown Box RRP 89.99 €





Goobay Pro

TV wall mount Pro FULLMOTION (XL)

for TVs from 43 to 100 inch (109-254 cm), fully mobile (swivel and tilt), up to 60 kg

- Perfect viewing angle and maximum flexibility through full mobility in tilt (up/down from +3° to -15°) and swivel (left/right by ±60°)
- The wall mount keeps the TV in the position with only 77 mm elegantly flat and space-saving on the wall and can be extended up to 428mm to achieve the optimal viewing angle.
- Adjustable scissor arm joint supports the extension and stabilizes the movement.
- Suitable wall bracket for most flat and curved televisions of all popular brands (e. g. Samsung (also QLED and LED), Sony, Philips, LG) and sizes (e. g. 50 inch, 55 inch, 58 inch, 65 inch, 75 inch, 85 inch)
- Easy mounting and compatible with VESA standards 300x200, 300x300, 400x200, 400x300, 400x400, 600x400, 800x400.



49746 Retail Box RRP 99.99 €

Wide Range Mount

Our heavyweight champion for tough challenges: Designed for a maximum load capacity of up to 80 kg, the wall mount effortlessly lifts all heavy TVs. With an extension range of 104.5 cm, the mount is extremely flexible - for the perfect viewing angle of the TV even from adjacent rooms.

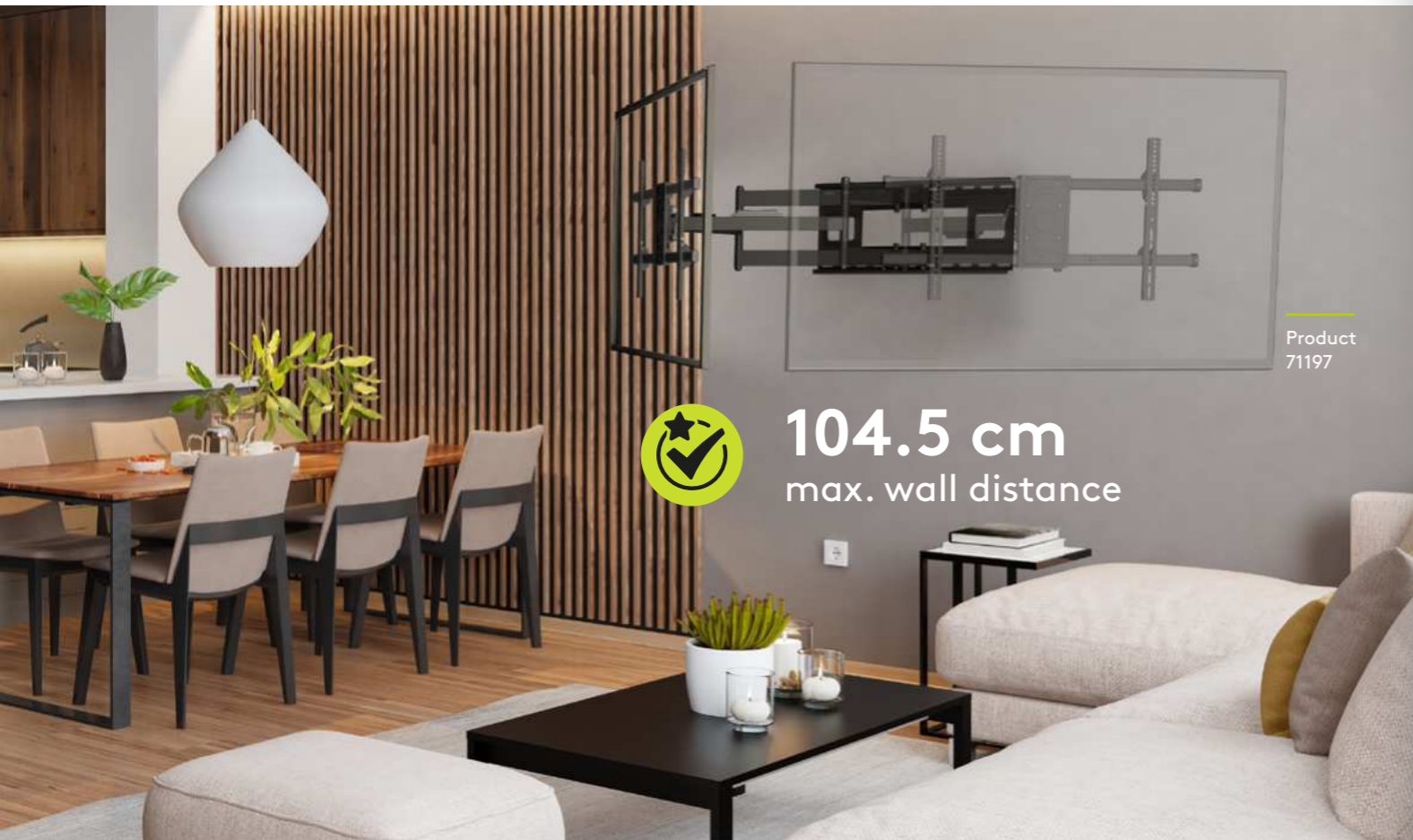

104.5 cm max. wall distance

Product 71197



Goobay Pro

TV wall mount Pro FULLMOTION (L) wide Range

for TVs from 37 to 70 inch (94-178 cm), fully mobile (swivel and tilt), up to 70 kg

- The „Wide Range“ function offers up to 800 mm wall distance in the extended state and allows a tilt angle of up to ±90° due to the extended arm, even with large screen sizes.
- Perfect viewing angle and maximum flexibility through full mobility in tilt (up/down from +3° to -15°) and swivel (left/right by ±90°)
- The wall bracket is suitable for most curved and flat screen TVs of popular brands, e.g. Samsung (QLED and LED), Sony, Philips and LG, as well as for many sizes (e.g. 40 inch, 43 inch, 49 inch, 50 inch, 55 inch, 58 inch, 65 inch).
- Easy mounting and compatible with VESA standards 200x100, 200x200, 300x200, 300x300, 400x200, 400x300, 400x400, 600x400.



49935 Retail Box RRP 149.99 €



Goobay Pro

Wide Range TV Wall Mount Pro FULLMOTION (XL)

mount for TVs from 43 to 90 inches (109–229 cm), max. 80 kg, extendable up to 104.5 cm, fully flexible: swivels and tilts

- Maximum flexible TV mount for an optimised viewing angle: +5/-15° tiltable (up/down), +60/-60° swivelling (left/right), 104.5 cm extendable
- By extending the mount up to 104.5 cm, the TV is in view even from difficult angles, e.g. from adjacent rooms
- With quick-release function to quickly and easily detach the TV from the mount
- The TV wall bracket is suitable for most curved and flat screen TVs from popular brands, e.g. Samsung (QLED and LED), Sony, Philips and LG as well as many sizes, e.g. 50 inch, 55 inch, 58 inch, 65 inch, 75 inch, 85 inch
- Compatible with VESA® standards 200x200 mm, 300x200 mm, 400x200 mm, 300x300 mm, 400x300 mm, 400x400 mm, 600x400 mm, 800x400 mm



71197 Brown Box RRP 149.99 €





### Goobay Basic

#### Adapter for TV Wall Mount with VESA Format

increases the spacing of the mounting holes of a TV set to a maximum of 200x200 mm

- The adapter can both extend and reduce the VESA hole spacing of a TV set to achieve the suitable size for a wall mount.
- The adapter extends the VESA hole spacing from 200x200 mm up to 400x400 mm.
- The maximum load depends on the respective wall bracket.
- High-quality manufacture from powder-coated metal, without burrs or sharp edges, with countersinks for the screw heads.
- Mounting material is included in the scope of delivery.

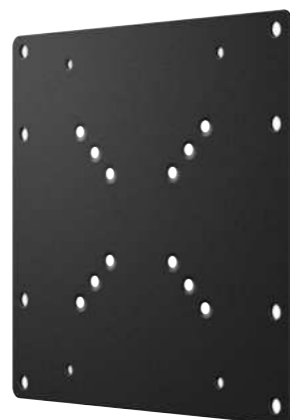

63267 Retail Box RRP 14.99 €



### Goobay Basic

#### Adapter for TV Wall Mount with VESA Format

increases the spacing of the mounting holes of a TV set to a maximum of 400x400 mm

- The adapter can both extend and reduce the VESA hole spacing of a TV set to achieve the suitable size for a wall mount.
- The adapter extends the VESA hole spacing from 200x200 mm up to 400x400 mm.
- The maximum load depends on the respective wall bracket.
- High-quality manufacture from powder-coated metal, without burrs or sharp edges.
- Mounting material is included in the scope of delivery.



60134 Retail Box RRP 24.99 €

## EasyMount Universal

The innovative, adjustable cable suspension provides a universal hole pattern compatibility and supports most TVs from 37 to 70 inches up to 50 kg. So you can hang your TV like a picture. The super slim design is only 14.5 mm away from the wall to complete the elegant look of ultra-thin TVs.



### Goobay Basic

#### TV Wall Mount EasyMount Universal

for TVs from 37" to 70" (94-178 cm) to 50 kg with flexible cable system

- Simply hang up like a picture thanks to the innovative rope suspension function. The wallmount is extremely flexible and universal in application.
- The ultra flat mounting keeps the TV elegantly flat and space-saving on the wall with only 14.5 mm.
- Suitable wall bracket for most flat and curved TVs of all popular brands (e. g. Samsung (also QLED and LED), Sony, Philips, LG) and sizes (e. g. 40 inch, 43 inch, 49 inch, 50 inch, 55 inch, 58 inch, 65 inch).
- Easy mounting and compatible with VESA standards 100x100, 200x100, 200x200, 300x300, 400x200, 400x400, 600x400, 800x400, 800x600, 800x800.



63490 Retail Box RRP 34.99 €

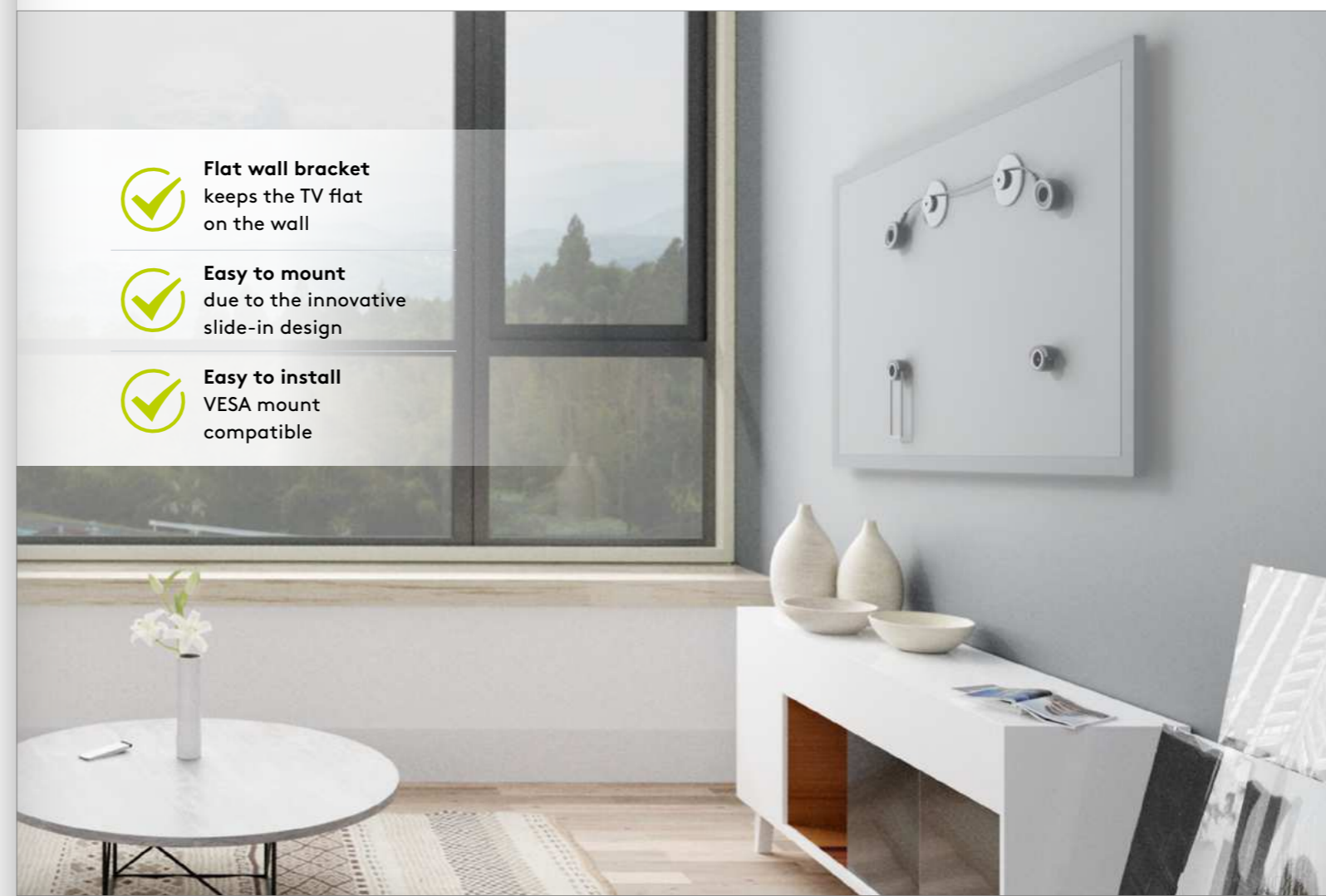

**Flat wall bracket**  
keeps the TV flat  
on the wall



**Easy to mount**  
due to the innovative  
slide-in design



**Easy to install**  
VESA mount  
compatible

### Ceiling TV Mount

Practical TV mount for installation on sloping ceilings, in or under cupboards and in various work areas.

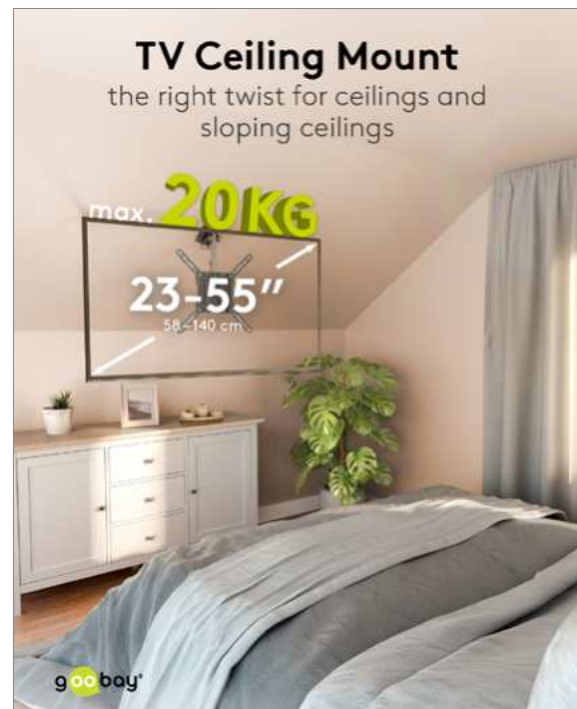

#### Goobay Basic

##### Ceiling TV Mount Basic (M)

mount for TVs from 23 to 55 inches (58 – 140 cm), max. 20 kg, swivels side-ways, ceiling angle variably adjustable, with flip-up and locking function

- Perfect for confined spaces: The secure snap-in function folds up the mount when not in use to create more space in the room and in or under cabinets
- The swivel mechanism in the ceiling mount allows for swivelling the TV by  $\pm 45^\circ$  to achieve an optimised viewing angle
- The height of the TV can be set using the adjustable rail (minimum TV height: 520 mm, maximum height: 614 mm)
- The TV wall bracket is suitable for most curved and flat screen TVs from popular brands, e.g. Samsung (QLED and LED), Sony, Philips and LG as well as many sizes, e.g. 32 inch, 40 inch, 43 inch, 50 inch, 55 inch
- Compatible with VESA® standards 75x75 mm, 100x100 mm, 100x200 mm, 200x100 mm, 200x200 mm, 200x300 mm, 300x200 mm, 200x400 mm, 400x200 mm, 300x300 mm, 300x400 mm, 400x300 mm, 400x400 mm



70824 Brown Box RRP 39.99 €



### Floor Stand

The metal TV floor stand with its solid glass base can be assembled in only a few minutes. With a swivel range of 35°, the stand offers you greater flexibility than standard TV mounts. You can also use the practical storage board for remote controls, laptops and other accessories.



#### Goobay Basic

##### TV Floor Stand Basic (Size L)

for TVs and monitors between 37 and 70 inch (94-178 cm) up to 40 kg, swivel

- flexible height adjustment, above-average swivel range
- floor stand can be set up in a few minutes
- TV cables can be hidden in the stand
- Suitable for TV sets with flat or curved design of all common sizes (e. g. 37 inch, 40 inch, 43 inch, 49 inch, 50 inch, 55 inch, 58 inch, 65 inch) and brands (Samsung, Sony, Philips, LG etc.)
- easy mounting, compatible with VESA standards 200x200, 300x200, 300x300, 400x200, 400x300, 400x400, 600x400

58526 Retail Box RRP 99.99 €



- ✓ Flexible Height-adjustable and swivelling
- ✓ Suitable for TVs with flat or curved design
- ✓ For a clean look Integrated cable management system
- ✓ Easy to install VESA mount compatible

## Presentation Stand

Our mobile TV presentation stand on casters offers maximum flexibility for offices, conference rooms, trade fairs or training sessions. With its sturdy design and height-adjustable mount, the TV stand can be used universally for many TV sizes.



### Goobay Basic

#### TV Presentation Stand Basic (Size L)

for TVs or monitors between 37 and 70 inch (94-178 cm), up to 35 kg

- integrated cable management system discreetly hides the cables in the stand
- presentation stand is set up in a few minutes
- Suitable for TV sets with flat or curved design of all common sizes (e. g. 37 inch, 40 inch, 43 inch, 49 inch, 50 inch, 55 inch, 58 inch, 65 inch) and brands (Samsung, Sony, Philips, LG etc.)
- easy mounting, compatible with VESA standards 100x100, 200x100, 200x200, 300x200, 300x300, 400x300, 400x200, 400x400



59507 Retail Box RRP 99.99 €



### Goobay Pro

#### TV Presentation Stand Pro (Size L)

for TVs and monitors between 37 and 70 inch (94-178 cm), up to 50 kg, tilt

- Ideal for various areas of use, e. g. at home, in offices, conferences, restaurants and hospitals
- camera shelf and shelf board height-adjustable (included in delivery)
- integrated cable management system for organising and protecting the connection cables
- Suitable for TV sets with flat or curved design of all common sizes (e. g. 37 inch, 40 inch, 43 inch, 49 inch, 50 inch, 55 inch, 58 inch, 65 inch) and brands (Samsung, Sony, Philips, LG etc.)
- easy mounting, compatible with VESA standards 100x100, 200x100, 200x200, 300x200, 300x300, 400x200, 400x300, 400x400, 600x400



59508 Retail Box RRP 149.00 €



## TV Stands

Our TV stands offer a compact, flexible alternative to fixed wall mounts. Quick and easy to set up, they can be placed on TV benches or sideboards without complicated wall mounting.



### Goobay Basic

#### Tabletop TV Stand Basic Fix

for TVs and monitors between 32 and 55 inch (81-140 cm), swivel

- compact TV stand for sets up to 40 kg, which can be flexibly integrated into the room concept
- Suitable for TV sets with flat or curved design of common sizes (e. g. 32 inch, 40 inch, 43 inch, 49 inch, 50 inch, 55 inch) and brands (Samsung, Sony, Philips, LG etc.) with QLED and LED
- integrated cable management system for organising and protecting the connection cables
- easy mounting, compatible with VESA standards 100x200, 200x100, 200x200, 300x200, 300x300, 400x200, 400x300, 400x400
- space-saving packaging for low-priced shipping



58524 Retail Box RRP 49.99 €



### Goobay Basic

#### TV Table Stand

for TVs and monitors between 32 and 70 inch (81-178 cm), up to 50 kg, tilt

- sturdy feet for placing TVs and monitors on tables or sideboards
- integrated cable management system for organising and protecting the connection cables
- foam foot pads protect furniture from scratches and scuffs
- Suitable for TV sets with flat or curved design of all common sizes (e. g. 32 inch, 40 inch, 43 inch, 49 inch, 50 inch, 55 inch, 58 inch, 65 inch) and brands (Samsung, Sony, Philips, LG etc.)
- easy mounting, compatible with VESA standards 75x75, 100x100, 100x150, 100x200, 150x100, 150x150, 200x100, 200x200, 300x200, 300x300, 400x200, 400x300, 400x400, 600x400, 800x400



58525 Retail Box RRP 29.99 €





Soundbar



Wall Mounts



Stands

### Soundbar Mount

The soundbar bracket adds a special touch to any home cinema system: the feet are simply and quickly attached to the wall, e.g. underneath the TV. The soundbar is thus set up for the perfect sound experience and complements the TV with a minimalist, clean look -without the need for elaborate base units or shelves.



#### Goobay Basic

##### Universal Soundbar Wall Mount

secure, discreet mount with padded feet for all common soundbars and single loudspeakers

- Variably adjustable mount for most common soundbars up to a depth of 90-154 mm, e.g. from Samsung, LG, Sonos, Sennheiser, Teufel or JBL
- The padded feet prevent scratches on the soundbar and neutralise potential vibrations during audio playback
- With its compact and discreet design, the soundbar mount blends perfectly into any room concept
- The locking screw on the underside enables quick and easy adjustment and a secure hold in the selected position
- Using screw mounting, the speaker bracket is easily attached to the wall



70827 Brown Box RRP 14.99 €



#### Goobay Basic

##### Universal Soundbar Mount for TV Sets

secure, discreet mount with padded feet for all common soundbars

- Variably adjustable mount for most common soundbars up to a depth of 86-155 mm, e.g. from Samsung, LG, Sonos, Sennheiser, Teufel or JBL
- The robust mounting rail can be screwed to the wall or attached directly to the back of the TV (VESA®-compatible up to 800x400 mm)
- When attached to the back of the TV, the soundbar can be positioned either above or below the TV set
- The padded feet prevent scratches on the soundbar and neutralise potential vibrations during audio playback
- With its compact and discreet design, the soundbar mount blends perfectly into any room concept
- The locking screw on the underside enables quick and easy adjustment and a secure hold in the selected position



70828 Brown Box RRP 29.99 €

## SPEAKER MOUNTS

FULL BASS AND TREBLE CONTROL

INDIVIDUALLY POSITIONED, OUR FLEXIBLE MOUNTS TAKE YOUR WORLD OF SOUND TO A NEW LEVEL



## Speaker Mount

Unleash the full potential of your speakers with perfect positioning: the wall bracket allows you to flexibly and individually align your satellite speakers to achieve excellent surround sound in any ambience -for immersive movie, music and entertainment experiences in your living room.

- With generous cable feed-through for conveniently connecting and disconnecting audio and mains cables
- Using screw mounting, the speaker bracket is easily attached to the wall



### Goobay Basic

#### Speaker mount universal

2 pieces, universal speaker holder for wall mounting, (swivel and tilt) for speakers up to max. 3.5kg

- Elegant and compact, the wall mount offers a secure hold and a variety of adjustment options.
- Ideal for surround and HiFi systems. Universally applicable for all speakers with a weight of up to 3.5 kg.
- Optimal and easy (tool-free) alignment due to the fine head joint (can be tilted up to 20° and tilted 70°).
- The speaker is mounted to the bracket using the screw points in the speaker. The wall mounting screws of the bracket disappear elegantly behind the cover.
- Suitable for speakers of all popular brands (e.g. Bose, B&O, Canton, Harman-Kardon, LG, Magnat, Philips, Pioneer, Samsung, Sony, Teufel, Yamaha)



black	49393	Retail Box	RRP	11.99 €
white	49394	Retail Box	RRP	11.99 €

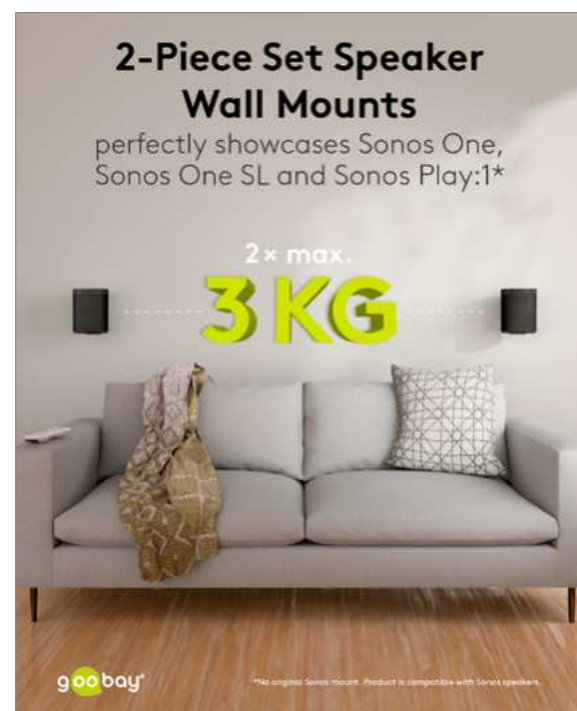

### Goobay Basic

#### Speaker Wall Mount One Sound Flex

2 pieces, compatible with the Sonos One and Sonos One SL, secure and fully flexible speaker mount

- Speaker mount made of robust metal for secure wall mounting of satellite speakers weighing up to 3 kg
- Compatible with speakers such as the Sonos One, Sonos One SL, Sonos Play:1
- Thanks to the stable joints, the wall mount steplessly tilts up to -20° and swivels ±45°
- The bracket can also be rotated by ±180° in order to hang the speaker upside down



black	70829	Brown Box	RRP	29.99 €
white	71348	Brown Box	RRP	29.99 €

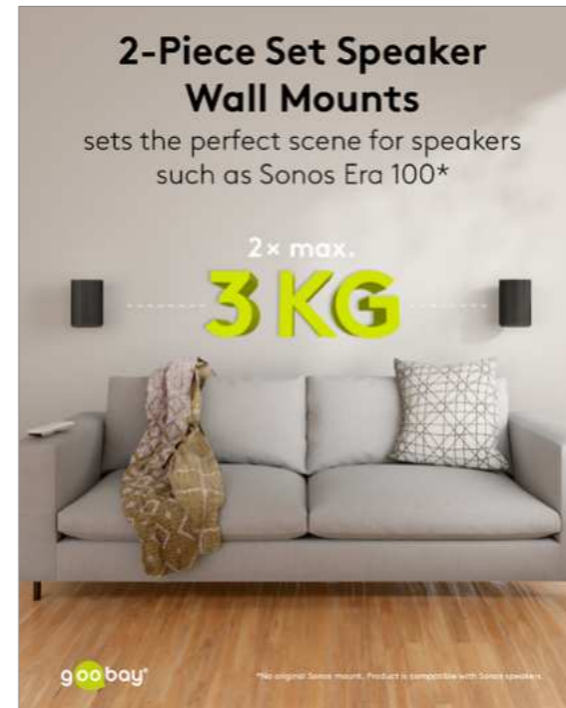

### Goobay Basic

#### Speaker Wall Mount Modern Era 1 Flex

2 pieces, compatible with the Sonos Era 100, swivelling and tilting speaker mount

- Speaker mount made of robust metal for secure wall mounting of satellite speakers weighing up to 3 kg
- Compatible with speakers such as the Sonos Era 100
- Due to its compact format, the mount can easily be positioned anywhere in order to achieve an excellent sound experience
- Thanks to the stable joints, the wall mount steplessly tilts up to -18° and swivels ±45°



black	71025	Brown Box	RRP	29.99 €
white	71982	Brown Box	RRP	29.99 €

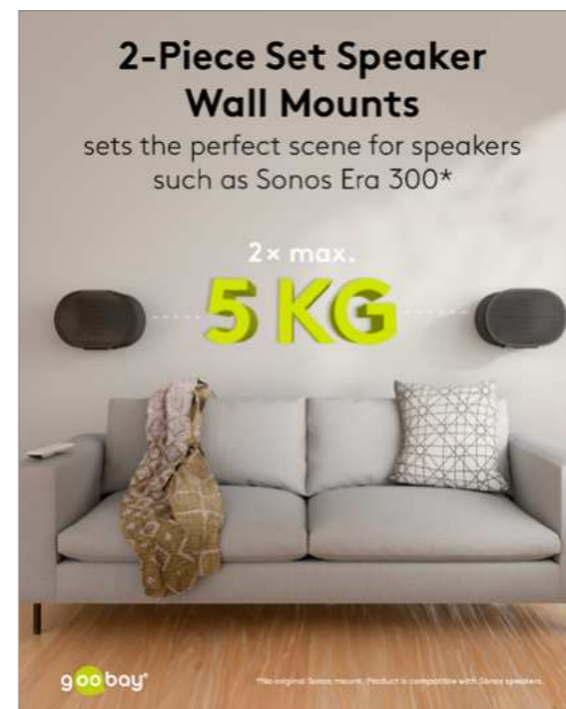

### Goobay Basic

#### Speaker Wall Mount Modern Era 3 Flex

2 pieces, compatible with the Sonos Era 300, secure and discreet speaker mount

- Speaker mount made of robust metal for secure wall mounting of satellite speakers weighing up to 5 kg
- Compatible with speakers such as the Sonos Era 300
- Due to its compact format, the mount can easily be positioned anywhere in order to achieve an excellent sound experience
- Thanks to the stable joints, the wall mount steplessly tilts up to -18° and swivels ±45°



black	71194	Brown Box	RRP	29.99 €
white	71984	Brown Box	RRP	29.99 €



## Speaker Stand

Unleash the full potential of your speakers with perfect positioning: the wall bracket allows you to flexibly and individually align your satellite speakers to achieve excellent surround sound in any ambience -for immersive movie, music and entertainment experiences in your living room.

- Speaker mount made of robust metal for securely mounting satellite speakers weighing up to 5 kg
- At 71.5 cm, the speaker stands are just the right height for an excellent listening and music experience while seated – on the sofa, at the desk or on the patio
- The cable management is discreetly concealed in the base for a clean look without cable clutter
- With cable feed-through for conveniently connecting and disconnecting audio and mains cables
- The speaker is quickly and easily fastened to the stand using screw mounting

**2-Piece Set Speaker Stands**  
sets the perfect stage for speakers such as Sonos Era 100\*

2 x max.  
**3 KG**

goobay

### Goobay Basic

#### Speaker Stand Modern Era 1 Base

2 pieces, compatible with the Sonos Era 100, with a minimalist design perfectly tailored to Sonos speakers

- Compatible with speakers such as the Sonos Era 100



black	71026	Brown Box	RRP	59.99 €
white	71983	Brown Box	RRP	59.99 €



**2-Piece Set Speaker Stands**  
sets the perfect stage for speakers such as Sonos Era 300\*

2 x max.  
**5 KG**

goobay

### Goobay Basic

#### Speaker Stand Modern Era 3 Base

2 pieces, compatible with the Sonos Era 300, with a minimalist design perfectly tailored to Sonos speakers

- Compatible with speakers such as the Sonos Era 300



black	71195	Brown Box	RRP	59.99 €
white	71985	Brown Box	RRP	59.99 €



## PROJECTOR CEILING MOUNTS

### TOP PERSPECTIVES FROM ABOVE

SPACE-SAVING ON THE CEILING,  
OUR MOUNTS KEEP A CLEAN LOOK IN YOUR HOME AND OFFICE



### Projector Ceiling Mounts

Whether for a home cinema experience or presentations in the office: Our flexible mounts ensure a perfect, secure positioning of the projector and are easy to install. As they are discreetly placed on the ceiling, they also ensure a balanced room appearance.



Goobay

#### Projector Ceiling Mount (M)

for small to medium-sized projectors, fully movable up to max. 10 kg

- The distance to the ceiling can be adjusted via the two mounting pipes (130 mm or 200 mm) included in the delivery
- The ceiling bracket can be tilted up to 15° and rotated by 360°
- The projector can easily be adjusted via the integrated axle joint even after installation
- The internal cable routing ensures a tidy appearance



white	51896	Retail Box	RRP	34.99 €
silver	51905	Retail Box	RRP	34.99 €



Tilt

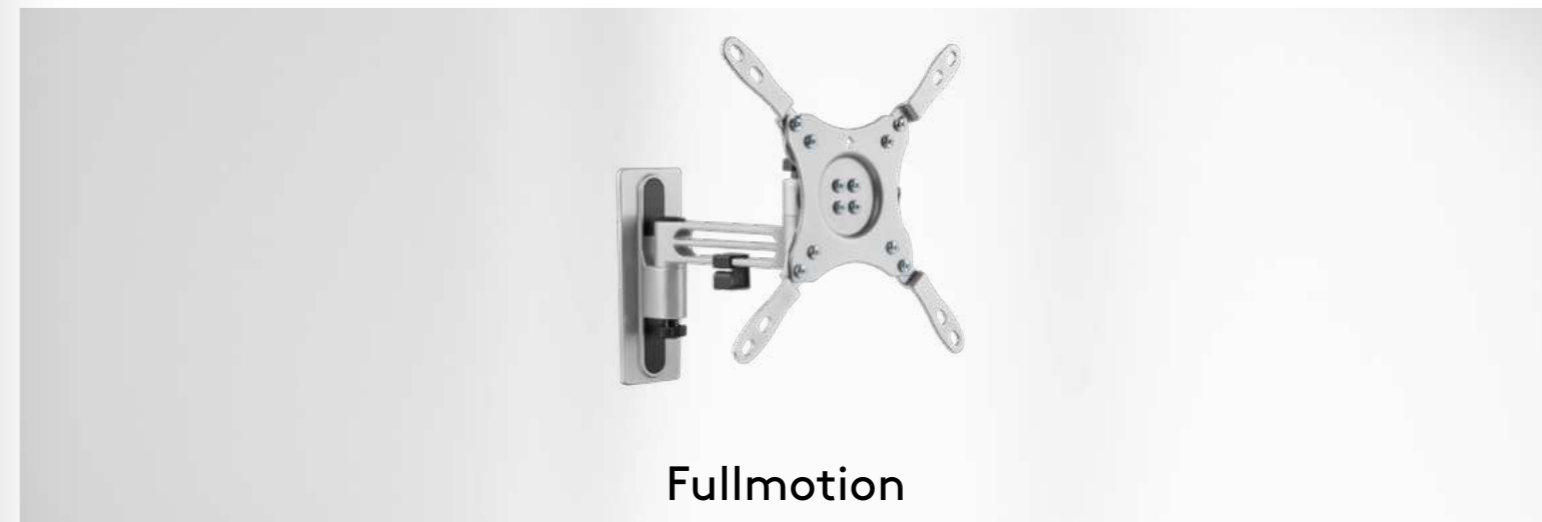

Fullmotion



Fixed

## CARAVAN – TV WALL MOUNTS

TRAVELS WITH YOUR TV

WITH OUR MOUNTS, YOU CAN TRAVEL THE WORLD WHILE ENJOYING TV PROGRAMMES JUST LIKE ON YOUR SOFA AT HOME



### Mounts for motorhome & caravan

The practical wall mount transforms your motorhome into a mobile home cinema: TV, movies and streaming for entertainment on the road and on vacation. For safe transportation -for a reliable hold and without annoying vibration noises while driving.

- Also suitable for heavy TV sets up to 30 kg
- Easy to install: In a first step, screw the TV to the mounting plate and in a second step, slide it onto the previously attached wall rail



#### Goobay Basic

##### TV Wall Mount Caravan FIXED (S),

mount for TVs from 13 to 27 inches (33–69 cm), max. 30 kg, ultra-flat design with only 15 mm wall clearance

- With a wall clearance of just 15 mm, the TV mount can be attached to the wall in a particularly flat and space-saving way
- The TV wall mount is suitable for most flat screen TVs from popular brands, e.g. Samsung (QLED and LED), Sony, Philips and LG, as well as for many sizes
- Compatible with VESA® standards 50x50 mm, 75x75 mm, 100x100 mm



74414 Brown Box RRP 9.99 €



#### Goobay Basic

##### TV Wall Mount Caravan FIXED (M),

mount for TVs from 23 to 42 inches (58–107 cm), max. 30 kg, ultra-flat design with only 18 mm wall clearance

- With a wall clearance of just 18 mm, the TV mount can be attached to the wall in a particularly flat and space-saving way
- The TV wall mount is suitable for most flat screen TVs from popular brands, e.g. Samsung (QLED and LED), Sony, Philips and LG as well as for many sizes (e.g. 32 inch, 40 inch, 42 inch)
- Compatible with VESA® standards 50x50 mm, 75x75 mm, 100x100 mm, 200x100 mm, 200x200 mm



74415 Brown Box RRP 19.99 €

- Designed for use in motorhomes or caravans, the wall mount has a locking mechanism and an anti-vibration joint for safe protection while travelling
- Easy to install: In a first first step, screw the TV to the mounting plate and in a second step, place it on the spike of the wall bracket
- Wall mounting is quick and easy with the included mounting material (incl. spirit level for precise alignment)
- The TV wall mount is suitable for most flat screen TVs from popular brands, e.g. Samsung (QLED and LED), Sony, Philips and LG as well as for many sizes (e.g. 32 inch, 40 inch, 43 inch)
- Compatible with VESA® standards 75x75 mm, 100x100 mm, 200x100 mm, 200x200 mm



#### Goobay Basic

##### TV Wall Mount Caravan TILT (M)

mount for TVs from 13 to 43 inches (33–109 cm), max. 15 kg, fully mobile: swivelling and tilting

- Perfect for stable wall mounting of a medium-sized TV up to 15 kg, tilts +45/-42° and swivels ±45° for the ideal viewing angle



71987 Brown Box RRP 19.99 €

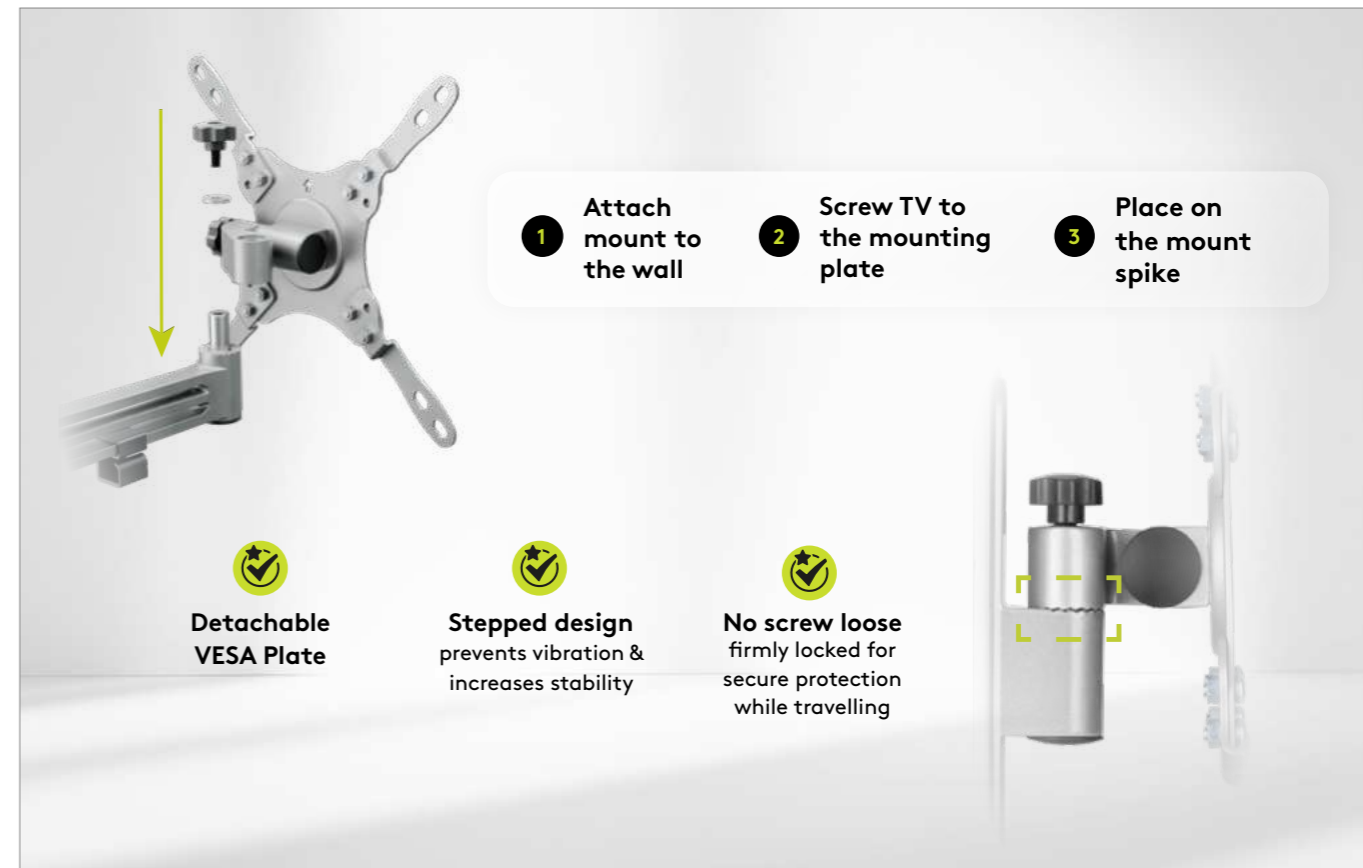





Goobay Basic

TV Wall Mount Caravan FULLMOTION (M)

mount for TVs from 13 to 43 inches (33–109 cm), max. 15 kg, fully mobile: swivelling, tilting, extendable up to 23.6 cm

- Perfect for stable wall mounting of a medium-sized TV up to 15 kg, tilts +55/-45° and swivels ±90° at each joint for the ideal viewing angle
- Extendable by up to 23.6 cm for extra flexibility



71988 Brown Box RRP 29.99 €



Goobay Basic

TV Wall Mount Caravan FULLMOTION (M)

mount for TVs from 13 to 43 inches (33–109 cm), max. 15 kg, fully mobile: swivelling, tilting, extendable up to 38.6 cm

- Perfect for stable wall mounting of a medium-sized TV up to 15 kg, tilts +55/-45° and swivels ±90° at each joint for the ideal viewing angle
- Extendable by up to 38.6 cm for extra flexibility









71989 Brown Box RRP 39.99 €























Category	Image	Item No.	Item	Series	Colour	Size	Max. Weight
MONITOR		58528	Monitor Mount Single Flex for curved and flat monitors	Basic	Black	17-32" 43-81 cm	8 kg
		58529	Dual Monitor Mount Flex for curved and flat monitors	Basic	Black	17-32" 43-81 cm	jeweils 8 kg
		59394	Double Monitor Mount Fix for curved and flat monitors	Basic	Black	17-32" 43-81 cm	each 9 kg
		58530	Monitor Mount with Gas Spring for curved and flat monitors	Basic	Black	17-32" 43-81 cm	9 kg
		58531	Double Monitor Mount with Gas Spring for curved and flat monitors	Basic	Black	17-32" 43-81 cm	each 9 kg
		70820	Single Monitor Wall Mount for wall mounting	Basic	Black	M 17-32" 43-81 cm	9 kg
		70821	Freestanding Single Monitor Mount fully flexible table stand	Basic	Black	M 17-32" 43-81 cm	8 kg
		70813	Single Monitor Mount with Gas Spring easy snap-in mounting of the arms	Pro	Black	M 17-32" 43-81 cm	9 kg
		70814	Dual Monitor Mount with Gas Spring easy snap-in mounting of the arms	Pro	Black	M 17-32" 43-81 cm	9 kg per monitor
		70815	Monitor Mount with Laptop Arm Flex workstation for monitors plus a laptop	Basic	Black	M 13-32" 33-81 cm	8 kg monitor 4.5 kg laptop 240-420 mm
		74417	Deluxe Monitor Mount with Laptop Arm workstation for monitors plus a laptop, easy snap-in mounting of the arms	Basic	Black	M 17-32" 43-81 cm	8 kg monitor 5 kg laptop 11.6-17.3" 287-465 mm
		70817	Laptop Mount for Monitor Arm for mounting on a monitor mount	Basic	Black	M 10-15,6" 25-40 cm	4,5 kg laptop size 10-15.6" 240-420 mm
		70818	Deluxe Laptop Mount for Monitor Arm for mounting on a monitor mount	Basic	Black	M 11,6-17,3" 29-44 cm	9 kg laptop size 11.6-17.3" 287-465 mm
		74416	Single Monitor Mount with Gas Spring tailored to large and heavy gaming and business monitors	Basic	Black	XL 17-49" 43-124 cm	20 kg

Category	Image	Item No.	Item	Series	Colour	Size	Max. Weight
TV FIXED		58523	TV Wall Mount Basic FIXED for TV sets and monitors	Basic	Black	S 23-42" 58-107 cm	25 kg
		49730	TV Wall Mount Basic FIXED	Basic	Black	M 32-55" 81-140 cm	35 kg
		49732	TV Wall Mount Basic FIXED	Basic	Black	L 37-70" 94-178 cm	35 kg
		49742	TV Wall Mount Basic FIXED	Basic	Black	XL 43-100" 109-254 cm	75 kg
		70822	Ultraslim TV Wall Mount Basic FIXED ultra-flat design with 9.5 mm wall distance	Basic	Black	XL 43-100" 109-254 cm	75 kg
		49949	TV wall mount OLED FIXED especially for OLED TVs	OLED	Black	L 37-70" 94-178 cm	50 kg
		49890	TV wall mount Pro FIXED	Pro	Black	M 32-55" 81-140 cm	50 kg
		49891	TV wall mount Pro FIXED	Pro	Black	L 37-70" 94-178 cm	50 kg
		49892	TV wall mount Pro FIXED	Pro	Black	XL 43-100" 109-254 cm	75 kg
	TV TILT		51893	TV Wall Mount Basic TILT for TVs and monitors, tilt and swivel	Basic	Black	S 23-42" 58-107 cm
		49731	TV Wall Mount Basic TILT tiltable	Basic	Black	M 32-55" 81-140 cm	35 kg
		49741	TV Wall Mount Basic TILT tiltable	Basic	Black	L 37-70" 94-178 cm	35 kg
		49743	TV Wall Mount Basic TILT tiltable	Basic	Black	XL 43-100" 109-254 cm	75 kg
		49909	TV Wall Mount Pro TILT tiltable	Pro	Black	M 32-55" 81-140 cm	70 kg
		49929	TV Wall Mount Pro TILT tiltable	Pro	Black	L 37-70" 94-178 cm	70 kg
		49930	TV Wall Mount Pro TILT tiltable	Pro	Black	XL 43-100" 109-254 cm	70 kg

Category	Image	Item No.	Item	Series	Colour	Size	Max. Weight	
TV FULLMOTION		49713	TV Wall Mount Basic FULLMOTION fully mobile (swivel and tilt)	Basic	Black	S 23-42" 58-107 cm	20 kg	
		49714	TV Wall Mount Basic FULLMOTION fully movable double arm joint (swivel and tilt)	Basic	Black	S 23-42" 58-107 cm	15 kg	
		49715	TV Wall Mount Basic FULLMOTION fully movable double arm joint (swivel and tilt)	Basic	Black	S 23-42" 58-107 cm	20 kg	
		49744	TV Wall Mount Basic FULLMOTION fully mobile (swivel and tilt)	Basic	Black	M 32-55" 81-140 cm	35 kg	
		49745	TV Wall Mount Basic FULLMOTION fully mobile (swivel and tilt)	Basic	Black	L 37-70" 94-178 cm	35 kg	
		71199	TV Wall Mount Basic FULLMOTION fully mobile (swivel and tilt)	Basic	Black	L 37-80" 94-203 cm	45 kg	
		49956	TV Wall Mount OLED FULLMOTION fully mobile (swivel and tilt)	OLED	Black	L 37-70" 94-178 cm	30 kg	
		49932	TV Wall Mount Pro FULLMOTION fully mobile (swivel and tilt)	Pro	Black	L 37-70" 94-178 cm	60 kg	
		71216	TV Wall Mount Pro FULLMOTION fully flexible: swivels, tilts, sideways adjustable	Pro	Black	XL 43-90" 109-229 cm	60 kg	
		49746	TV Wall Mount Pro FULLMOTION fully mobile (swivel and tilt)	Pro	Black	XL 43-100" 109-254 cm	60 kg	
		49935	TV Wall Mount Pro FULLMOTION wide Range fully mobile (swivel and tilt)	Pro	Black	L 37-70" 94-178 cm	70 kg	
		71197	Wide Range TV Wall Mount Pro FULLMOTION extendable up to 104.5 cm, fully flexible: swivels and tilts	Pro	Black	XL 43-90" 109-229 cm	80 kg	
	TV ACCESSORIES		63267	Adapter for TV Wall Mount with VESA Format increases the spacing of the mounting holes of a TV set to a maximum of 200x200 mm	Basic	Black		
			60134	Adapter for TV Wall Mount with VESA Format increases the spacing of the mounting holes of a TV set to a maximum of 400x400 mm	Basic	Black		

Category	Image	Item No.	Item	Series	Colour	Size	Max. Weight
TV UNIVERSAL		63490	TV Wall Mount EasyMount Universal with flexible cable system	Basic	Black	L 37-70" 94-178 cm	50 kg
TV CEILING MOUNT		70824	Ceiling TV Mount Basic swivels sideways, ceiling angle variably adjustable, with flip-up and locking function	Basic	Black	M 23-55" 58-140 cm	20 kg
TV FLOOR STANDS & FEET		58526	TV Floor Stand Basic for TVs and monitors, swivel	Basic	Black	L 37-70" 94-178 cm	40 kg
		59507	TV Presentation Stand Basic for TVs or monitors	Basic	Black	L 37-70" 94-178 cm	35 kg
		59508	TV Presentation Stand Pro for TVs and monitors, tilt	Pro	Black	L 37-70" 94-178 cm	50 kg
		58524	Tabletop TV Stand Basic Fix for TVs and monitors, swivel	Basic	Black	32-55" 81-140 cm	40 kg
		58525	TV Table Stand for TVs and monitors, tilt	Basic	Black	32-70" 81-178 cm	50 kg

Category	Image	Item No.	Item	Series	Colour	Size	Max. Weight
SPEAKER		70827	Universal Soundbar Wall Mount secure, discreet mount with padded feet for all common soundbars and single loudspeakers	Basic	Black		15 kg
		70828	Universal Soundbar Mount for TV Sets secure, discreet mount with padded feet for all common soundbars	Basic	Black		15 kg
		49393	Speaker mount universal universal speaker holder for wall mounting, (swivel and tilt)	Basic	Black		3,5 kg
		49394			White		
		70829	Speaker Wall Mount One Sound Flex 2 pieces, compatible with the Sonos One and Sonos One SL, secure and fully flexible speaker mount	Basic	Black		3 kg
		71348			White		
		71025	Speaker Wall Mount Modern Era 1 Flex 2 pieces, compatible with the Sonos Era 100, swivelling and tilting speaker mount	Basic	Black		3 kg
		71982			White		
		71194	Speaker Wall Mount Modern Era 3 Flex 2 pieces, compatible with the Sonos Era 300, secure and discreet speaker mount	Basic	Black		5 kg
		71984			White		
		71026	Speaker Stand Modern Era 1 Base 2 pieces, compatible with the Sonos Era 100, with a minimalist design perfectly tailored to Sonos speakers	Basic	Black		3 kg
		71983			White		
	71195	Speaker Stand Modern Era 3 Base 2 pieces, compatible with the Sonos Era 300, with a minimalist design perfectly tailored to Sonos speakers	Basic	Black		5 kg	
	71985			White			

Category	Image	Item No.	Item	Series	Colour	Size	Max. Weight
PROJECTOR		51896	Projector Ceiling Mount for small to medium-sized projectors, fully movable	Basic	White	M	10 kg
		51905			Silver		
CARAVAN		71987	TV Wall Mount Caravan TILT fully mobile: swivelling and tilting	Basic	Silver	M 13-43" 33-109 cm	15 kg
		71988	TV Wall Mount Caravan FULLMOTION fully mobile: swivelling, tilting, extendable up to 23.6 cm	Basic	Silver	M 13-43" 33-109 cm	15 kg
		71989	TV Wall Mount Caravan FULLMOTION fully mobile: swivelling, tilting, extendable up to 38.6 cm	Basic	Silver	M 13-43" 33-109 cm	15 kg
		74414	TV Wall Mount Caravan FIXED ultra-flat design with only 15 mm wall clearance	Basic	Black	S 13-27" 33-69 cm	30 kg
		74415	TV Wall Mount Caravan FIXED ultra-flat design with only 18 mm wall clearance	Basic	Black	M 23-42" 58-107 cm	30 kg

Wentronic GmbH  
Pillmannstr. 12, 38112 Braunschweig, Germany

Tel/Fax +49 - 5 31 - 2 10 58 - 0/ -22  
E-Mail: [office@wentronic.com](mailto:office@wentronic.com)



[wentronic.com](http://wentronic.com)